



Technify Motors GmbH
Platanenstraße 14
D - 09356 St. Egidien

Tel. +49-(0)37204/ 696-0
Fax +49-(0)37204/ 696-2912
www.continentaldiesel.de
support@continentaldiesel.de

Supplement Pilot's Operating Handbook for the Cessna 172 R & S

Equipped with TAE 125-02-114 Installation

Issue 2

MODEL No. _____

SERIAL No. _____

REGISTER No. _____

This supplement must be attached to the EASA approved Pilot's Operating Handbook when the TAE 125-02-114 installation has been installed in accordance with EASA STC 10014287.

The information contained in this supplement supersedes or adds to the information published in the EASA approved Pilot's Operating Handbook only as set forth herein.

For limitations, procedures, performance and loading information not contained in this supplement, consult the EASA approved Pilot's Operating Handbook.

This supplement Pilot's Operating Handbook is approved with EASA STC 10014287.



Doc.-No.: 20-0310-22122



This page intentionally left blank

APPROVAL

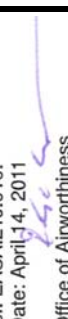
The content of approved chapters is approved by EASA. All other content is approved by TAE under the authority of EASA DOA No. EASA.21J.010 in accordance with Part 21.

LOG OF REVISIONS

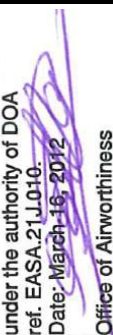
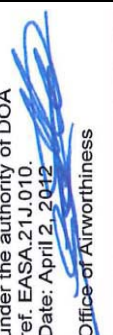
Revision	Section	Description	Approved	
			Date	Endorsed
2/0	all	new Issue	May 21, 2010	EASA STC 10014287
2/1	1	New oil, editorial changes	April 14, 2011	Revision No. 1 to AFM supplement ref. 20-0310-22122 is approved under the authority of DOA ref. EASA.21J.010. Date: April 14, 2011  Office of Airworthiness
	2	New oil, editorial changes		
	3	Procedures updated		
	4	Procedures updated		
	5	Editorial changes		
	7	Editorial changes		
	8	Editorial changes		
	9	New Section		
2/2	1	New gearbox oil	June 30, 2011	Revision No. 2 to AFM supplement ref. 20-0310-22122 is approved under the authority of DOA ref. EASA.21J.010. Date: June 30, 2011  Office of Airworthiness
	2	New gearbox oil		
	4	Procedures updated		

Revision	Section	Description	Approved	
			Date	Endorsed
2/3	1	New fuel, new gearbox oil	March 16, 2012	<p>Revision No. 3 to AFM supplement ref. 20-0310-22122 is approved under the authority of DOA ref. EASA.21J.010. Date: March 16, 2012</p>  <p>Office of Airworthiness</p>
	2	New fuel, new gearbox oil		
	4	New fuel, Procedures updated		
	5	Procedures updated		
	8	New fuel		
2/4	1	Correction	April 2, 2012	<p>Revision No. 4 to AFM supplement ref. 20-0310-22122 is approved under the authority of DOA ref. EASA.21J.010. Date: April 2, 2012</p>  <p>Office of Airworthiness</p>
	2	Correction		
2/5	1	New gearbox oil	March 11, 2013	<p>Revision No. 5 to AFM supplement ref. 20-0310-22122 is approved under the authority of DOA ref. EASA.21J.010. Date: March 11, 2013</p>  <p>Office of Airworthiness</p>
	2	New gearbox oil		
	5	Procedures updated		

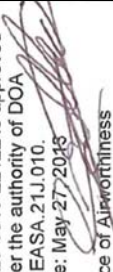
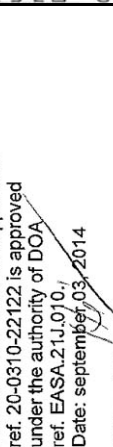
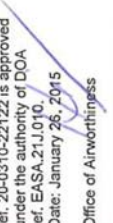
Revision	Section	Description	Approved	
			Date	Endorsed
2/6	---	EASA STC / AFM numbers corrected on the cover	May 27, 2013	Revision No. 6 to AFM supplement ref. 20-0310-22122 is approved under the authority of DOA ref. EASA.21.J.010. Date: May 27, 2013  Office of Airworthiness
2/7	1	Safety Recommendation New fuel New gearbox oil Note fuel additive	03.09.2014	Revision No. 7 to AFM supplement ref. 20-0310-22122 is approved under the authority of DOA ref. EASA.21.J.010. Date: september 03, 2014  Office of Airworthiness
	2	Note added New fuel New gearbox oil Note fuel additive	03.09.2014	
	3	Description adapted	03.09.2014	
	4	Note added	03.09.2014	
	5	Wording	03.09.2014	
	6	Wording	03.09.2014	
	7	Wording	03.09.2014	
	8	Wording	03.09.2014	
	9	Wording	03.09.2014	
2/8	4	Procedure added	26.01.2015	Revision No. 8 to AFM supplement ref. 20-0310-22122 is approved under the authority of DOA ref. EASA.21.J.010. Date: January 26, 2015  Office of Airworthiness

Revision	Section	Description	Approved	
			Date	Endorsed
2/9	1	New propeller	April 08, 2015	EASA STC 10014287, Rev. 8
	5	splitted due to new propeller specs		
	5a	New section		
	5b	New section		
2/10	1	Wording	Dec. 15, 2015	EASA STC 10014287, Rev. 9
	2	Wording		
2/11	1	Update liquids	Nov. 08., 2016	EASA STC 10014287, Rev. 11
	2	Implementation of G1000 with Engine Indication System		
	3	Implementation of G1000 with Engine Indication System		
	4	splitted for Implementation of G1000 with Engine Indication System		
	4a	New section		
	4b	New section		
	7	Implementation of G1000 with Engine Indication System		
2/12	2	Note added for CAAC	Jan. 22, 2018	Revision No. 10 to AFM supplement ref. 20-0310-22122 is approved under the authority of DOA ref. EASA.21J.010. Date: Jan. 22, 2018  Office of Airworthiness
	3	Update		
	4a	Minor corrections Update FADEC Test above 5500ft		
	4b	Procedure update Update FADEC Test above 5500ft		

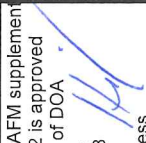
Revision	Section	Description	Approved	
			Date	Endorsed
2/13	4b	Procedure update	May 08, 2018	 Revision No. 13 to AFM supplement ref. 20-0310-22122 is approved under the authority of DOA ref. EASA.21J.010 Date: May 08, 2018 Office of Airworthiness
	5	Figure updated		

Remark: The parts of the text which changed are marked with a vertical line on the margin of the page.

LIST OF EFFECTIVE SECTIONS

Sections	Issue/Revision	Date
1	2/10	Nov. 08, 2016
2	2/10	Jan. 22, 2018
3	2/9	Jan. 22, 2018
4	2/8	Nov. 08, 2016
4a	2/1	Jan. 22, 2018
4b	2/2	May 08, 2018
5	2/9	May 08, 2018
5a	2/0	April 08, 2015
5b	2/0	April 08, 2015
6	2/7	Sept. 03, 2014
7	2/8	Nov. 08, 2016
8	2/7	Sept. 03, 2014
9	2/7	Sept. 03, 2014

GENERAL REMARK

The content of this POH supplement is developed on basis of the EASA-approved POH.

TABLE OF CONTENTS

COVER SHEET

LOG OF REVISIONS page iii

LIST OF EFFECTIVE SECTIONS page viii

GENERAL REMARK page viii

TABLE OF CONTENTS page ix

CONVERSION TABLES page x

ABBREVIATIONS page xiv

SECTION 1	GENERAL (a non-approved chapter)
SECTION 2	LIMITATIONS (an approved chapter)
SECTION 3	EMERGENCY PROCEDURES (a non-approved chapter)
SECTION 4	NORMAL PROCEDURES (a non-approved chapter)
SECTION 5	PERFORMANCE (a non-approved chapter)
SECTION 6	WEIGHT & BALANCE (a non-approved chapter)
SECTION 7	AIRPLANE & SYSTEMS DESCRIPTION (a non-approved chapter)
SECTION 8	HANDLING, SERVICE & MAINTENANCE (a non-approved chapter)
SECTION 9	SUPPLEMENTS

CONVERSION TABLES

VOLUME		
Unit [Abbr.]	Conversion factor SI to US / Imperial	Conversion factor US / Imperial to SI
Liter [l] US gallon [US gal] US quart [US qt] Imperial gallon [Imp gal] Cubic inch [in ³]	$[l] / 3.7854 = [\text{US gal}]$ $[l] / 0.9464 = [\text{US qt}]$ $[l] / 4.5459 = [\text{Imp gal}]$ $[l] \times 61.024 = [\text{in}^3]$	$[\text{US gal}] \times 3.7854 = [l]$ $[[\text{US qt}] \times 0.9464 = [l]$ $[[\text{Imp gal}] \times 4.5459 = [l]$ $[\text{in}^3] / 61.024 = [l]$
TORQUE		
Unit [Abbr.]	Conversion factor SI to US / Imperial	Conversion factor US / Imperial to SI
Kilopondmeter [kpm] Foot pound [ft.lb] Inch pound [in.lb]	$[\text{kpm}] \times 7.2331 = [\text{ft.lb}]$ $[\text{kpm}] \times 86.7962 = [\text{in.lb}]$	$[\text{ft.lb}] / 7.2331 = [\text{kpm}]$ $[\text{in.lb}] / 86.7962 = [\text{kpm}]$
TEMPERATURE		
Unit [Abbr.]	Conversion factor SI to US / Imperial	Conversion factor US / Imperial to SI
Degree Celsius [°C] Degree Fahrenheit [°F]	$[°C] \times 1.8 + 32 = [°F]$	$([°F] - 32) / 1.8 = [°C]$
SPEED		
Unit [Abbr.]	Conversion factor SI to US / Imperial	Conversion factor US / Imperial to SI
Kilometers per hour [km/h] Meters per second [m/s] Miles per hour [mph] Knots [kts] Feet per minute [fpm]	$[\text{km/h}] / 1.852 = [\text{kts}]$ $[\text{km/h}] / 1.609 = [\text{mph}]$ $[\text{m/s}] \times 196.85 = [\text{fpm}]$	$[\text{mph}] \times 1.609 = [\text{km/h}]$ $[\text{kts}] \times 1.852 = [\text{km/h}]$ $[\text{fpm}] / 196.85 = [\text{m/s}]$

PRESSURE		
Unit [Abbr.]	Conversion factor SI to US / Imperial	Conversion factor US / Imperial to SI
Bar [bar] Hectopascal [hpa] =Millibar [mbar] Pounds per square inch [psi] inches of mercury column [inHg]	$[\text{bar}] \times 14.5038 = [\text{psi}]$ $[\text{hpa}] / 33.864 = [\text{inHg}]$ $[\text{mbar}] / 33.864 = [\text{inHg}]$	$[\text{psi}] / 14.5038 = [\text{bar}]$ $[\text{inHg}] \times 33.864 = [\text{hPa}]$ $[\text{inHg}] \times 33.864 = [\text{mbar}]$
MASS		
Unit [Abbr.]	Conversion factor SI to US / Imperial	Conversion factor US / Imperial to Si
Kilogramm [kg] Pound [lb]	$[\text{kg}] / 0.45359 = [\text{lb}]$	$[\text{lb}] \times 0.45359 = [\text{kg}]$
LENGTH		
Unit [Abbr.]	Conversion factor SI to US / Imperial	Conversion factor US / Imperial to Si
Meter [m] Millimeter [mm] Kilometer [km] Inch [in] Foot [ft] Nautical mile [nm] Statute mile [sm]	$[\text{m}] / = 0.3048 [\text{ft}]$ $[\text{mm}] / = 25.4 [\text{in}]$ $[\text{km}] / = 1.852 [\text{nm}]$ $[\text{km}] / = 1.609 [\text{sm}]$	$[\text{in}] \times 25.4 = [\text{mm}]$ $[\text{ft}] \times 0.3048 = [\text{m}]$ $[\text{nm}] \times 1.852 = [\text{km}]$ $[\text{sm}] \times 1.609 = [\text{km}]$
FORCE		
Unit [Abbr.]	Conversion factor SI to US / Imperial	Conversion factor US / Imperial to Si
Newton [N] Decanewton [daN] Pound [lb]	$[\text{N}] / 4.448 = [\text{lb}]$ $[\text{daN}] / 0.4448 = [\text{lb}]$	$[\text{lb}] \times 4.448 = [\text{N}]$ $[\text{lb}] \times 0.4448 = [\text{daN}]$

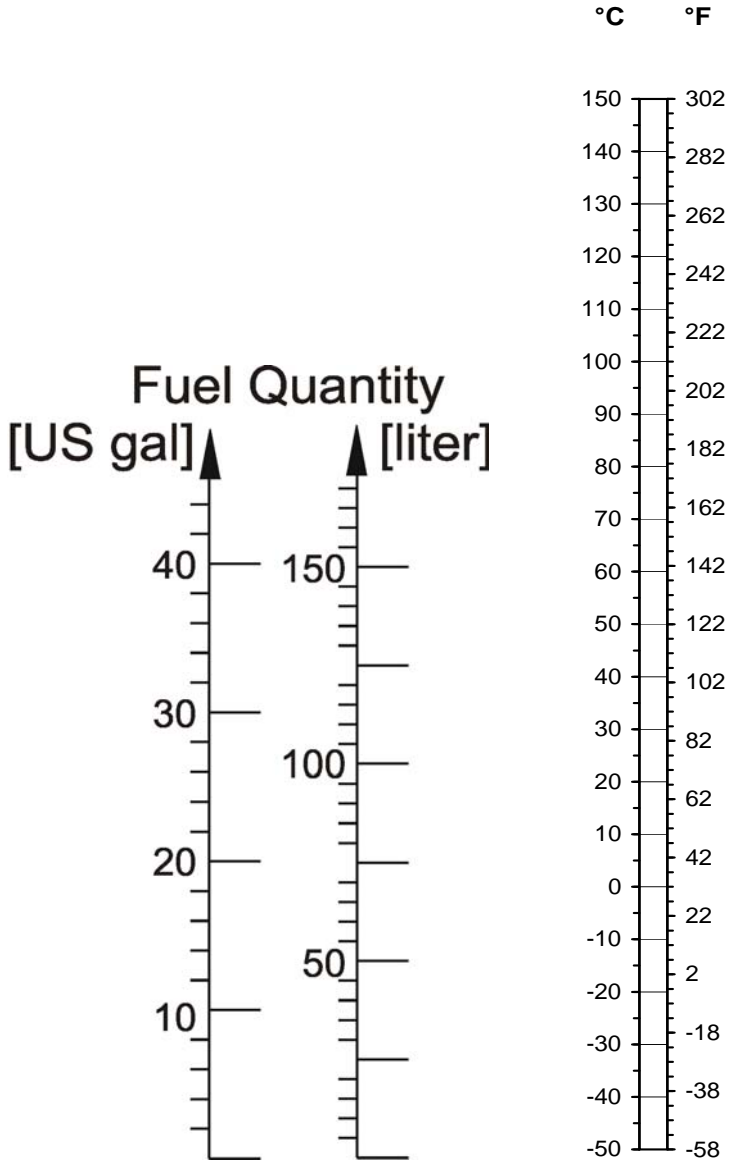

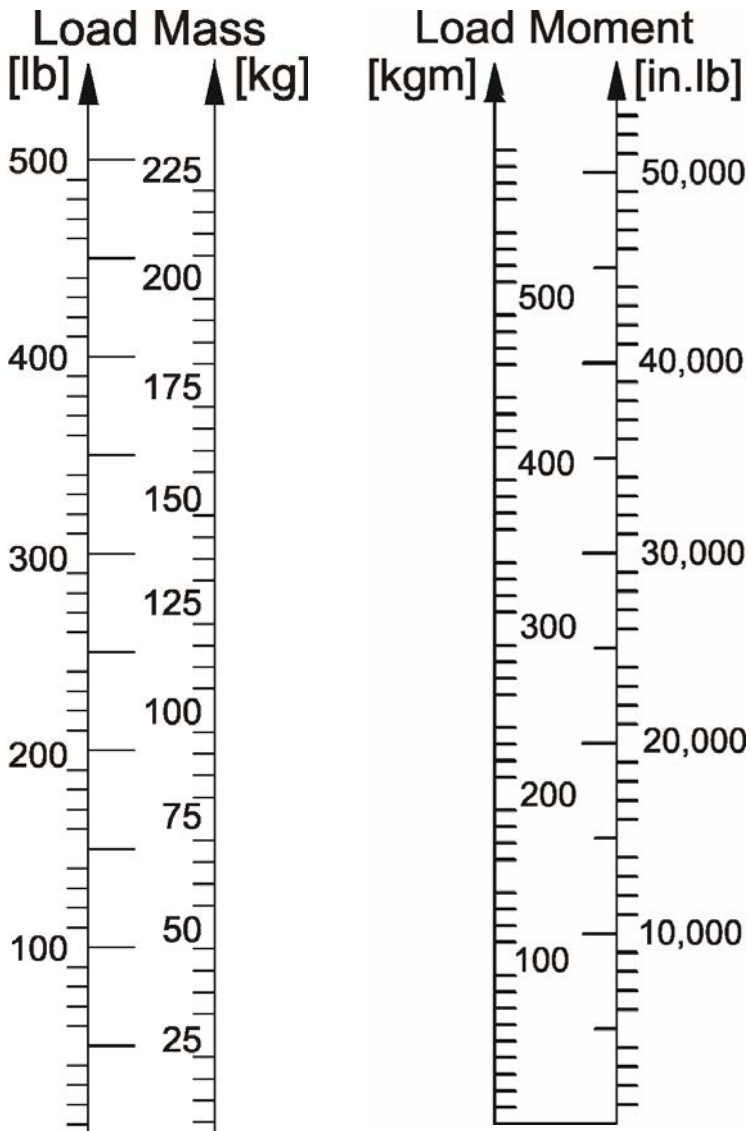

ABBREVIATIONS

FADEC	Full Authority Digital Engine Control
CED 125	Compact Engine Display Multifunctional instrument for indication of engine data of the TAE 125-02-114
AED 125	Auxiliary Engine Display Multifunctional instrument for indication of engine and airplane data
G1000	Garmin 1000 Multifunctional display

SECTION 1 GENERAL

Safety Recommendations

The following symbols and warnings are used in this manual. They must be heeded strictly to prevent personal injury and material damage, to avoid impairment of the operational safety of the aircraft and to rule out any damage to the aircraft as a consequence of improper handling.

▲ **WARNING:** Non-compliance with these safety rules could lead to injury or even death.

■ **CAUTION:** Non-compliance with these special notes and safety measures could cause damage to the engine or to the other components.

◆ **Note:** Information added for a better understanding of an instruction.

UPDATE AND REVISION OF THE MANUAL

▲ **WARNING:** A safe operation is only assured with an up to date POH supplement. Information about actual POH supplement issues and revisions are published in the Service Bulletin TM TAE 000-0004.

◆ **Note:** The Doc.-No of this POH supplement is published on the cover sheet of this supplement.

ENGINE

▲ **WARNING:** The engine requires an electrical power source for operation. If the main battery and alternator fail, the engine will only operate for a maximum of 30 minutes on FADEC backup battery power. Therefore, it is important to pay attention to indications of alternator failure.

Engine manufacturer:..... Technify Motors GmbH

Engine model:TAE 125-02-114

The TAE 125-02-114 is a liquid cooled in-line four-stroke 4-cylinder turbocharged engine with DOHC (double overhead camshaft), direct fuel injection and common-rail technology. It has a displacement of 1991 ccm (121.5 in³). The engine is controlled by a FADEC system. The propeller is driven by a built-in gearbox (i = 1.69) with mechanical vibration dampening and overload release. The engine has an electrical self starter and an alternator.

Due to this specific characteristic, all of the information from the are no longer valid with reference to:

- carburetor and carburetor pre-heating
- ignition magnetos and spark plugs, and
- mixture control and priming system

PROPELLER

Manufacturer:.....MT Propeller Entwicklung GmbH

Model: MTV-6-A/187-129

..... MTV-6-A/190-69

Number of blades:..... 3

Diameter: 1.87 m (MTV-6-A/187-129

..... 1.90 m (MTV-6-A/190-69)

Type:.....constant speed

FUELS and LIQUIDS

▲ **WARNING:** The engine must not be started under any circumstances if any fluid level is too low.

■ **CAUTION:** Use of unapproved fuels may result in damage to the engine and fuel system components, resulting in possible engine failure.

■ **CAUTION:** Use approved oil with exact designation only!

■ **CAUTION:** Normally it is not necessary to fill the cooling liquid or gearbox oil between maintenance intervals. If the level is too low, please notify the service center immediately.

Fuel:JET A-1 (ASTM 1655)

..... JET A (ASTM 1655)

..... Jet Fuel No.3 (GB 6537-2006)

.....JP-8 (MIL-DTL-83133E)

.....JP-8+100 (MIL-DTL-83133E)

..... TS-1 (GOST 10227-86)

..... TS-1 (GSTU 320.00149943.011-99)

Alternative: Diesel (**DIN** EN 590)

..... SASOL GTL Diesel

◆ Note: The liquid fuel additive Biobor JF can be used in jet and diesel fuel systems to eliminate growth of fungi. For further details refer to the manufacturer specifications.

Engine oil: AeroShell Oil Diesel Ultra
..... AeroShell Oil Diesel 10W-40
..... Shell Helix Ultra 5W-30
..... Shell Helix Ultra 5W-40

Gearbox oil: Centurion Gearbox Oil N1
..... Shell Spirax S6 ATF ZM
..... Shell Spirax S6 GXME 75W-80, API GL-4
..... Shell Spirax S4 G 75W-90, API GL-4

Coolant:.....Water/Radiator Protection at a ratio of 50:50

Radiator Protection: BASF Glysantin Protect Plus / G48
..... Valvoline/Zerex Glysantin G48
..... Mobil Antifreeze Extra (G48)
..... Comma Xstream Green - Concentrate/G48

◆ Note: The freezing point of the coolant is -36°C.

Quantity of fuel:

-
- ◆ Note: The maximum permissible tank capacity has been reduced due to the higher specific density of Jet A-1 and Diesel compared to AVGAS
-

C172 R&S normal category:

Total capacity:180.2 litres (47.6 US gallons)
Total capacity of usable fuel:168.8 litres (44.6 US gallons)
Total capacity each tank:90.1 litres (23.8 US gallons)
Total capacity of usable fuel
each tank:84.4 litres (22.3 US gallons)

C172 R&S utility category:

Total capacity:117.4 litres (31 US gallons)
Total capacity of usable fuel:106 litres (28 US gallons)
Total capacity each tank: 58.7 litres(15.5 US gallons)
Total capacity of usable fuel
each tank:53 litres (14 US gallons)

WEIGHT LIMITS**C172 R normal category:**

Maximum Ramp Weight: 1112 kg (2452 lbs)

Maximum Takeoff Weight: 1111 kg (2450 lbs)

Maximum Landing Weight 1111 kg (2450 lbs)

If LBA-EMZ SA1358 (FAA STC SA2196CE) is installed:

Maximum Ramp Weight: 1135 kg (2502 lbs)

Maximum Takeoff Weight: 1134 kg (2500 lbs)

Maximum Landing Weight 1134 kg (2500 lbs)

C172 R utility category:

Maximum Ramp Weight: 954 kg (2102 lbs)

Maximum Takeoff Weight: 953 kg (2100 lbs)

Maximum Landing Weight 953 kg (2100 lbs)

C172 S normal category;**C172 R with Cessna Mod. KIT MK172-72-01 normal category:**

Maximum Ramp Weight: 1158 kg (2552 lbs)

Maximum Takeoff Weight: 1157 kg (2550 lbs)

Maximum Landing Weight 1157 kg (2550 lbs)

C172 S utility category:

Maximum Ramp Weight: 1000 kg (2202 lbs)

Maximum Takeoff Weight: 999 kg (2200 lbs)

Maximum Landing Weight 999 kg (2200 lbs)

SECTION 2 LIMITATIONS

▲ **WARNING:** It is not allowed to start up the engine using external power. If starting the engine is not possible using battery power, the condition of the battery must be verified before flight.

◆ Note: In the absence of any other explicit statements, all of the information on RPM in this supplement to the Pilot's Operating Handbook are propeller RPM.

◆ Note: This change of the original aircraft is certified up to an altitude of 18,000 ft.

ENGINE OPERATING LIMITS

Engine manufacturer:..... Technify Motors GmbH
Engine model:TAE 125-02-114
Take-off and Max. continuous power:..... 114 kW (155 HP)
Take-off and Max. continuous RPM:..... 2300 min⁻¹
Max. recommended cruise:..... 85%

**ENGINE OPERATING LIMITS FOR TAKE-OFF AND
CONTINUOUS OPERATION**

▲ **WARNING:** It is not allowed to start the engine outside of these temperature limits.

◆ **Note:** The operating limit temperature is a temperature limit below which the engine may be started, but not operated at the Take-off RPM. The warm-up RPM to be selected can be found in Section 4 of this supplement.

Oil temperature:

Minimum engine starting temperature: -32 °C
Minimum operating limit temperature:..... 50 °C
Maximum operating limit temperature:..... 140 °C

Coolant temperature:

Minimum engine starting temperature: -32 °C
Minimum operating limit temperature: 60 °C
Maximum operating limit temperature:..... 105 °C

Gearbox temperature:

Minimum operating limit temperature:..... -30 °C
Maximum operating limit temperature:..... 120 °C

MIN. FUEL TEMPERATURE LIMITS IN THE FUEL TANK

▲ **WARNING:** The fuel temperature of the fuel tank not used should be monitored if its later use is intended.

▲ **WARNING:** The following applies to Diesel and JET fuel mixtures in the tank:
 As soon as the proportion of Diesel in the tank is more than 10% Diesel, the fuel temperature limits for Diesel operation must be monitored. If there is uncertainty about which fuel is in the tank, the assumption should be made that it is Diesel.

Fuel	Minimum fuel temperature in the fuel tank before Take-off	Minimum fuel temperature in the fuel tank during the flight
JET A-1, JET A, Fuel No.3 JP-8, JP-8+100 TS-1	-30°C (-22°F)	-35°C (-31°F)
Diesel Sasol GTL Diesel	greater than 0°C(32°F)	-5°C (23°F)

Table 2-3a Minimum fuel temperature limits in the fuel tank

Minimum oil pressure: 1.2 bar
 Minimum oil pressure (at Take-off power) 2.3 bar
 Minimum oil pressure (in flight) 2.3 bar
 Maximum oil pressure 6.0 bar
 Maximum oil pressure (cold start < 20 sec.): 6.5 bar
 Maximum oil consumption: 0.1 l/h (0.1 quart/h)

ENGINE INSTRUMENT MARKINGS

The engine data of the installation to be monitored are integrated in the compact engine instrument CED-125 and the auxiliary engine display AED-125 (conventional avionics) or indicated via G1000 display.

The ranges of the individual engine monitoring parameters are shown in the following tables.

◆ Note: "Load" describes the available percentage of maximum engine power.

AED/CED

Instrument CED		Red range	Amber range	Green range	Amber range	Red range
Tachometer	[RPM]	-----	-----	0-2300	-----	> 2300
Oil pressure	[bar]	0 - 1.1	1.2 - 2.2	2.3 - 5.1	5.2 - 6.5	> 6.5
	[psi]	0 - 16	17.4 - 32	33.4 - 74	75.4 - 94.2	> 94.2
Coolant temperature	[°C]	< -32	-32...+59	60 - 100	101 - 105	> 105
Oil temperature	[°C]	< -32	-32...+49	50 - 129	130 - 140	> 140
Gearbox temperature	[°C]	-----	-----	< 115	115 - 120	> 120
Load	[%]	-----	-----	0 - 100	-----	-----

Table 2-3b Markings (CED)

Instrument AED		Red range	Amber range	Green range	Amber range	Red range
Fuel Temperature (left and right)	[°C]	< -30	-30...-1	0 - 69	70 - 75	> 75
Alternator Current	[A]	-----	-----	0 - 52.4	52.5 - 60	>60
Electrical System Voltage	[V]	0 - 21	22 - 24	25 - 29.4	29.5 - 30	>30

Table 2-3 Markings (AED)



Figure 2-1 AED/CED

◆ Note:

The AED/CED caution lamp is switched on if an engine reading is in the amber or red range.

The AED/CED caution lamp remains on even when the parameter returns to the green/normal operating range and must be confirmed by pressing the Confirm/Test knob.

After being confirmed, the AED/CED caution lamp will switch on again whenever another parameter enters amber/red range. Pressing the Confirm/Test knob longer than one second will initiate the power-up test sequence.

WARNING/CAUTION OVERVIEW

Ereignis	Conventional Avionics via lightpanel/AED/CED	
FADEC Warning	FADEC A	Red Light
	FADEC B	Red Light
Alternator Failure	Alt	Red Light
AED/CED Failure	AED	Amber Light
	CED	Amber Light
Glow Failure	Glow	Amber Light
Fuel Quantity	Fuel L	Amber Light
	Fuel R	Amber Light
Fuel Temp.	AED	Amber, Red Range
Coolant Temp.	CED	
Gearbox Temp.		
Oil Temp.		
Oil Pressure		
Propeller Speed	CED	Red Range
FORCE B active	Indicated by switch position	
Engine coolant level is low	AED	„Water Level“ light

Table 2-3d Warnings/Cautions (AED/CED)

G1000 with Engine Indicating System

G1000		Red range	Amber range	Green range	Amber range	Red range
Tachometer	[RPM]	-----	-----	0-2300	-----	> 2300
Oil pressure OFF, START, IDLE	[bar]	0 - 1.1	-----	1.2 - 5.1	5.2 - 6.5	> 6.5
	[psi]	0 - 16	-----	17.4 - 74	75.4 - 94.2	> 94.2
Oil pressure above IDLE	[bar]	0 - 1.1	1.2 - 2.2	2.3 - 5.1	5.2 - 6.5	> 6.5
	[psi]	0 - 16	17.4 - 32	33.3 - 74	75.4 - 94.2	> 94.2
Coolant temperature	[°C]	< -32	-32...+59	60 - 100	101 - 105	> 105
Oil temperature	[°C]	< -32	-32...+49	50-129	130-140	> 140
Gearbox temperature	[°C]	-----	-----	< 115	115 - 120	> 120
Load	[%]	-----	-----	0-100	-----	-----
Fuel Temp. on ground	[°C]	< -30	-30...-1	0 - 65	66 - 75	> 75
Fuel Temp. in flight	[°C]	< -35	-35...-6	-5...+65	66 - 75	> 75
Alternator Current	[A]	-----	-----	0-52	53-70	>70

Table 2-5 Markings (G1000 with Engine Indication System)



Figure 2-2 Engine Display Page G1000 (MFD)

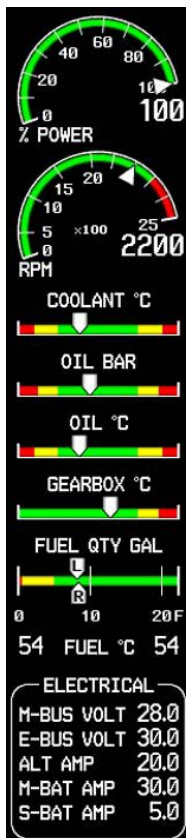

Figure 2-3 Engine Display Strip G1000

Annunciation Window Text	Annunciation Type	Color	Audio Alert
OIL PRESSURE	Warning	Red	Continuous Aural Tone
	Caution	Yellow	Single Aural Tone
LOW FUEL L	Caution	Yellow	Single Aural Tone
LOW FUEL R	Caution	Yellow	Single Aural Tone
STBY BATT	Caution	Yellow	Single Aural Tone
CO LVL HIGH	Warning	Red	Continuous Aural Tone
FADEC A	Warning	Red	Continuous Aural Tone
FADEC B	Warning	Red	Continuous Aural Tone
ALTERNATOR	Warning	Red	Continuous Aural Tone
COOLANT TEMP	Warning	Red	Continuous Aural Tone
	Caution	Yellow	Single Aural Tone
OIL TEMP	Warning	Red	Continuous Aural Tone
OIL TEMP	Caution	Yellow	Single Aural Tone
GEARBOX TEMP	Warning	Red	Continuous Aural Tone
	Caution	Yellow	Single Aural Tone
COOLANT LVL	Caution	Yellow	Single Aural Tone
HIGH RPM	Warning	Red	Continuous Aural Tone
FUEL TEMP	Warning	Red	Continuous Aural Tone
	Caution	Yellow	Single Aural Tone
STARTER ENGD	Warning	Red	Continuous Aural Tone
HIGH AMPS	Warning	Red	Continuous Aural Tone
LOW VOLTS	Warning	Red	Continuous Aural Tone above 30 kts No Tone below 30 kts
HIGH VOLTS	Warning	Red	Continuous Aural Tone
PITCH TRIM	Warning	Red	No Tone
LOW VACUUM	Caution	Yellow	Single Aural Tone

Table 2-3f Warnings/Cautions/Indications (G1000 Engine Indication System)

An alert annunciation shall be considered "active" from the time it is triggered until the condition is no longer valid (i.e. has been resolved).

-
- ◆ Note: STARTER ENGAGED is a warning alert annunciation without inhibits. The alert annunciation is active, when starter switch is engaged for more than 20s or the engine is running and the starter would engage
-

Alert Annunciation Priority indication G1000:

Advisory: Info only

- white text and black background

Caution: Not confirmed

- yellow text and black background
- Accepted via softkey for CAUTION

Warning: Not confirmed

- Red text and black background
- Accepted via softkey for WARNING

WEIGHT LIMITS

C172 R normal category:

Maximum Ramp Weight: 1112 kg (2452 lbs)

Maximum Takeoff Weight: 1111 kg (2450 lbs)

Maximum Landing Weight 1111 kg (2450 lbs)

If LBA-EMZ SA1358 (FAA STC SA2196CE) is installed:

Maximum Ramp Weight: 1135 kg (2502 lbs)

Maximum Takeoff Weight: 1134 kg (2500 lbs)

Maximum Landing Weight 1134 kg (2500 lbs)

C172 R utility category:

Maximum Ramp Weight: 954 kg (2102 lbs)

Maximum Takeoff Weight: 953 kg (2100 lbs)

Maximum Landing Weight 953 kg (2100 lbs)

C172 S normaly category;

C172 R with Cessna Mod. KIT MK172-72-01 normal category:

Maximum Ramp Weight: 1158 kg (2552 lbs)

Maximum Takeoff Weight: 1157 kg (2550 lbs)

Maximum Landing Weight 1157 kg (2550 lbs)

C172 S utility category:

Maximum Ramp Weight: 1000 kg (2202 lbs)

Maximum Takeoff Weight: 999 kg (2200 lbs)

Maximum Landing Weight 999 kg (2200 lbs)

MANEUVER LIMITS

■ CAUTION: Intentionally initiating negative G maneuvers is prohibited!

Normal Category: No change

Utility Category: Intentionally initiating spins is prohibited

FLIGHT LOAD FACTORS

No change

■ **CAUTION:** Avoid extended negative g-loads duration. Extended negative g-loads can cause propeller control and engine problems.

◆ **Note:** The load factor limits for the engine must also be observed. Refer to the Operation & Maintenance Manual for the engine.

PERMISSIBLE FUEL GRADES

■ **CAUTION:** Using non-approved fuels and additives can lead to dangerous engine malfunctions.

Fuel:JET A-1 (ASTM 1655)
.....JET A (ASTM 1655)
..... Jet Fuel No.3 (GB 6537-2006)
.....JP-8 (MIL-DTL-83133E)
.....JP-8+100 (MIL-DTL-83133E)
..... TS-1 (GOST 10227-86)
..... TS-1 (GSTU 320.00149943.011-99

Alternative: Diesel (**DIN** EN 590)
..... SASOL GTL Diesel

◆ **Note:** The liquid fuel additive Biobor JF can be used in jet and diesel fuel systems to eliminate growth of fungi. For further details refer to the manufacturer specifications.

MAXIMUM FUEL QUANTITIES

Due to the higher specific density of Kerosene in comparison to Aviation Gasoline (AVGAS) the permissible tank capacity has been reduced.

■ **CAUTION:** To prevent air from penetrating into the fuel system avoid running one tank dry. As soon as the "Low Level" caution light illuminates, switch to the tank with sufficient fuel or land as soon as possible.

■ **CAUTION:** With $\frac{1}{4}$ tank or less, prolonged uncoordinated flight is prohibited when operating on either left or right tank.

■ **CAUTION:** In turbulent air it is strongly recommended to use the BOTH position.

◆ **Note:** The tanks are equipped with a Low Fuel Warning.
For conventional avionics:
If the fuel level is below 19 l (5 US gal) usable fuel per tank, the "Fuel L" or "Fuel R" warning light illuminates respectively.
For G1000: Refer to original POH.

C172 R&S normal category:

Total capacity:180.2 litres (47.6 US gallons)

Total capacity of usable fuel:168.8 litres (44.6 US gallons)

Total capacity each tank:90.1 litres (23.8 US gallons)

Total capacity of usable fuel

each tank:84.4 litres (22.3 US gallons)

C172 R&S utility category:

Total capacity: 117.4 litres (31 US gallons)
Total capacity of usable fuel: 106 litres (28 US gallons)
Total capacity each tank: 58.7 litres (15.5 US gallons)
Total capacity of usable fuel
each tank: 53 litres (14 US gallons)

PERMISSIBLE OIL TYPES

■ **CAUTION:** Use approved oil with exact designation only!

Engine oil: AeroShell Oil Diesel Ultra
..... AeroShell Oil Diesel 10W-40
..... Shell Helix Ultra 5W-30
..... Shell Helix Ultra 5W-40
Gearbox oil: Centurion Gearbox Oil N1
..... Shell Spirax S6 ATF ZM
..... Shell Spirax S6 GXME 75W-80, API GL-4
..... Shell Spirax S4 G 75W-90, API GL-4

PERMISSIBLE COOLING LIQUID

Coolant: Water/Radiator Protection at a ratio of 50:50
Radiator Protection: BASF Glysantin Protect Plus / G48
..... Valvoline/Zerex Glysantin G48
..... Mobil Antifreeze Extra (G48)
..... Comma Xstream Green - Concentrate/G4 48

PLACARDS

Near the fuel tank caps:

for normal category aircraft:
JET FUEL ONLY
JET A-1 / DIESEL
CAP. 84.4 LITERS (22.3 U.S. GAL.)
USABLE TO BOTTOM OF FILLER INDICATOR TAB

◆ Note: The placard for CAAC region additionally lists Jet Fuel No. 3 in Chinese (中国 3 号航煤).

for utility category aircraft:
JET FUEL ONLY
JET A-1 / DIESEL
CAP. 53 LITERS (14 U.S. GAL.)

At the fuel selector valve:

for normal category aircraft:

Left and Right Position: 84.4 Ltr/ 22.3 gal
Both Position: 168.8 Ltr/ 44.6 gal

for utility category aircraft:

Left and Right position: 53 Ltr/ 14 gal
Both position: 106 Ltr/ 28 gal

On the oil funnel or at the flap of the engine cowling:

"Oil, see POH supplement"

Next to the Alternator Warning Light:

"Alternator"

If installed, at the flap of the engine cowling to the External
Power Receptacle:

All further placards contained in this section of the remain valid.

This page intentionally left blank

SECTION 3 EMERGENCY PROCEDURES

INDEX OF CHECKLISTS

ENGINE MALFUNCTION	3-2
During Take-off (with sufficient Runway ahead).....	3-2
Immediately after Take-off.....	3-3
During Flight	3-3
Restart after Engine Failure	3-4
FADEC Warning.....	3-5
Abnormal Engine Behavior.....	3-7
FIRES	3-8
Engine Fire when starting Engine on Ground	3-8
Engine Fire during Take-OFF (on Ground)	3-8
Engine Fire in Flight	3-8
Electrical Fire in Flight	3-9
ENGINE SHUT DOWN IN FLIGHT	3-10
EMERGENCY LANDING	3-10
Emergency Landing with Engine out	3-10
FLIGHT IN ICING CONDITIONS	3-11
RECOVERY FROM SPIRAL DIVE	3-12
ELECTRICAL POWER SUPPLY SYSTEM MALFUNCTIONS	3-13
Alternator Warning during normal Engine Operation	3-15
Ammeter shows Battery Discharge during normal Engine Operation for more than 5 Minutes	3-16
Total Electrical Failure	3-17
ROUGH ENGINE OPERATION OR LOSS OF POWER	3-18
Decrease in Power	3-18
Oil pressure too low.....	3-19
Oil temperature "OT" too high:	3-19
Coolant temperature "CT" too high:.....	3-20
"Water Level" Light illuminates / Caution COOL LVL.....	3-20
Gearbox temperature "GT" too high:	3-20
Fuel Temperature too high:	3-20
Fuel Temperature too low:	3-21
Propeller RPM too high:	3-21
Fluctuations in Propeller RPM:.....	3-22

GENERAL

In addition to the original AFM/POH, the following applies:

▲ **WARNING:** Due to failures indicated by the FADEC warning lights there might be a loss propeller valve current which leads in a low pitch setting of the propeller. This might result in overspeed.

Airspeeds below 100 KIAS are suitable to avoid overspeed in failure case. If the propeller speed control fails, climbs can be performed at 65 KIAS and a power setting of 100%.

◆ **Note:** Refer to the original POH for emergency procedures for the aircraft with G1000 if not otherwise stated herein.

EMERGENCY PROCEDURES CHECK LIST

ENGINE MALFUNCTION

DURING TAKE-OFF (WITH SUFFICIENT RUNWAY AHEAD)

- (1) Thrust Lever – IDLE
- (2) Brakes – APPLY
- (3) Wing flaps (if extended) – RETRACT to increase the braking effect on the runway
- (4) Engine Master – OFF
- (5) Alternator Main Bus and Battery switch – OFF
- (6) Fuel Shut-off Valve – CLOSED

IMMEDIATELY AFTER TAKE-OFF

If there is an engine malfunction after take-off, at first lower the nose to keep the airspeed and attain gliding attitude. In most cases, landing should be executed straight ahead with only small corrections in direction to avoid obstacles.

▲ WARNING: Altitude and airspeed are seldom sufficient for a return to the airfield with a 180° turn while gliding.

- (1) Airspeed..... 65 KIAS (wing flaps retracted)
.....60 KIAS (wing flaps extended)
- (2) Fuel Shut-off Valve – CLOSED
- (3) Engine Master – OFF
- (4) Wing flaps – as required (30° recommended)
- (5) Alternator, Main Bus and Battery switch – OFF

DURING FLIGHT

-
- ◆ **Note:** Running a tank dry activates both FADEC warning lights flashing.
-

In case that one fuel tank was flown empty, at the first signs of insufficient fuel feed proceed as follows:

- (1) Fuel Shut-off Valve – OPEN (push full in)
- (2) Immediately switch the Fuel Selector to BOTH position
- (3) Electric Fuel Pump – ON
- (4) Check the engine (engine parameters, airspeed/altitude change, whether the engine responds to changes in the Thrust Lever position).
- (5) If the engine acts normally, continue the flight and land as soon as possible.

-
- ▲ **WARNING:** The high-pressure pump must be checked by an authorized service center before the next flight.
-

RESTART AFTER ENGINE FAILURE

Whilst gliding to a suitable landing strip, try to determine the reason for the engine malfunction. If time permits and a restart of the engine is possible, proceed as follows:

- (1) Airspeed between 65 and 85 KIAS (maximal 100 KIAS)
- (2) Glide below 13,000 ft
- (3) Fuel Shut-off Valve – OPEN (push full in)
- (4) Fuel Selector switch to BOTH position
- (5) Electric Fuel Pump – ON
- (6) Thrust Lever – IDLE
- (7) Engine Master OFF and then ON
(if the propeller does not turn, then additionally Starter ON)

-
- ◆ Note: The propeller will normally continue to turn as long as the airspeed is above 65 KIAS. Should the propeller stop at an airspeed of more than 65 KIAS or more, the reason for this should be found out before attempting a restart.

If it is obvious that the engine or propeller is blocked, do not use the Starter.

- ◆ Note: If the Engine Master is in position OFF, the Load Display shows no value even if the propeller is turning.
-

- (8) Check the engine power: Thrust lever 100%, engine parameters, check altitude and airspeed.

FADEC WARNING

-
- ◆ Note: The FADEC consists of two components that are independent of each other: FADEC A and FADEC B. In case of malfunctions in the active FADEC, it automatically switches to the other.
-

a) One FADEC Light/FADEC warning is flashing

1. Press FADEC test knob/switch at least 2 seconds
2. FADEC warning extinguished (LOW category warning):
 - a) Continue flight normally
 - b) Inform service center after landing
3. Steady FADEC Light/warning (HIGH category warning)
 - a) Observe the other FADEC light / warning
 - b) Land as soon as possible
 - c) Select an airspeed to avoid engine overspeed
 - d) Inform service center after landing

b) Both FADEC Lights/warnings are flashing

◆ **Note:** CED load display should be considered unreliable with both FADEC lights illuminated. Use other indications to assess engine condition.

1. Press FADEC test knob at least 2 seconds
2. FADEC Lights/warnings extinguished (LOW category warning):
 - a) Continue flight normally
 - b) Inform service center after landing
3. Steady FADEC Lights/warnings (HIGH category warning):
 - a) Check the available engine power
 - b) Expect engine failure
 - c) Flight can be continued, however the pilot should
 - i) Select an appropriate airspeed to avoid engine overspeed.
 - ii) Land as soon as possible
 - iii) Be prepared for an emergency landing
 - d) Inform service center after landing
4. In case a fuel tank was flown empty, proceed at the first signs of insufficient fuel feed as follows:
 - a) Immediately switch the Fuel Selector to BOTH
 - b) Electric Fuel Pump – ON
 - c) Select an airspeed to avoid engine overspeed.
 - d) Check the engine (engine parameters, airspeed/altitude change, whether the engine responds to changes in the Thrust Lever position).
 - e) If the engine acts normally, continue the flight and land as soon as possible.

▲ **WARNING:** The high-pressure pump must be checked by an authorized service center before the next flight.

ABNORMAL ENGINE BEHAVIOR

If the engine acts abnormal during flight and the system does not automatically switch to the B-FADEC, it is possible switch to the B-FADEC manually.

▲ **WARNING:** It is only possible to switch from the automatic position to B-FADEC (A-FADEC is active in normal operation, B-FADEC is active in case of malfunction). This only becomes necessary when no automatic switching occurred in case of abnormal engine behavior.

(1) Select an appropriate airspeed to avoid engine overspeed.

▲ **WARNING:** When operating on FADEC backup battery only, the "Force B" switch **MUST** not be activated. This will shut down the engine.

(2) "FORCE-B" switch to B-FADEC

(3) Flight may be continued, but the pilot should:

- i) Select an airspeed to avoid engine overspeed
- ii) Land as soon as possible
- iii) Be prepared for an emergency landing

FIRES

ENGINE FIRE WHEN STARTING ENGINE ON GROUND

- (1) Engine Master – OFF
- (2) Fuel Shut-off Valve – CLOSED
- (3) Electric Fuel Pump – OFF
- (4) Battery Switch – OFF
- (5) Extinguish the flames with a fire extinguisher, wool blankets or sand.
- (6) Inform service center after landing for examination of fire damages.

ENGINE FIRE DURING TAKE-OFF (ON GROUND)

- (1) Engine Master – OFF
- (2) Fuel Selector – CLOSED
- (3) Electric Fuel Pump – OFF
- (4) Battery switch – OFF
- (5) Extinguish the flames with a fire extinguisher, wool blankets or sand.
- (6) Inform service center after landing for examination of fire damages.

ENGINE FIRE IN FLIGHT

- (1) Engine Master – OFF
- (2) Fuel Shut-off Valve – CLOSED
- (3) Select an airspeed to avoid engine overspeed
- (4) Electric Fuel Pump – OFF
- (5) Switch "Battery" – OFF
- (6) Cabin heat and ventilation OFF resp. CLOSE (except the fresh air nozzles on the ceiling)
- (7) Perform emergency landing (as described in the procedure "Emergency Landing With Engine Out")

ELECTRICAL FIRE IN FLIGHT

The first sign of an electrical fire is an unmistakable sharp, acrid smell. As the fire grows, electrical load might be higher than normal or circuit breakers start to trip. In this event proceed as follows:

- (1) STBY BATT Switch – OFF (G1000 Avionics)
- (2) Avionics Master – OFF
- (3) Fresh air nozzles, Cabin Heat and Ventilation – OFF (closed)
- (4) Fire Extinguisher – Activate (if available)
- (5) All electrical consumers – Switch OFF, leave Alternator, battery and Engine Master ON

▲ **WARNING:** After the fire extinguisher has been used, make sure that the fire is extinguished before exterior air is used to remove smoke from the cabin.

- (6) If there is evidence of continued electrical fire, consider turning off battery and alternator.

▲ **WARNING:** If both alternator and main battery are turned OFF, continued engine operation is dependent on the remaining capacity of the FADEC backup battery. The engine has been demonstrated to continue operating for a maximum of 30 minutes when powered by the FADEC backup battery only.

- (7) Fresh Air Nozzles, Cabin Heat and Ventilation – ON (open)
- (8) Check Circuit Breakers, do not reset if open

If the fire has been extinguished:

- (9) STBY BATT Switch – ON(G1000 Avionics)
- (10) Avionics Master – ON

▲ **WARNING:** Turn on electrical equipment required to continue flight depending on the situation and land as soon as possible. Switch circuit breakers switch ON one at a time, with delay after each.

ENGINE SHUT DOWN IN FLIGHT

If it is necessary to shut down the engine in flight (for instance, abnormal engine behavior does not allow continued flight or there is a fuel leak, etc.), proceed as follows:

- (1) Select an airspeed to avoid engine overspeed (best glide recommended)
- (2) Engine Master – OFF
- (3) Fuel Shut-off Valve – CLOSED
- (4) Electric Fuel Pump – OFF
- (5) If the propeller also has to be stopped (for instance, due to excessive vibrations)
 - i) Reduce airspeed below 55 KIAS
 - ii) When the propeller is stopped, continue to glide at 65 KIAS

EMERGENCY LANDING

EMERGENCY LANDING WITH ENGINE OUT

If all attempts to restart the engine fail and an emergency landing is immanent, select suitable site and proceed as follows:

- (1) Airspeed
 - i) 65 KIAS (flaps retracted)
 - ii) 60 KIAS (flaps extended)
- (2) Fuel Shut-off Valve – CLOSED,
- (3) Engine Master – OFF
- (4) Wing Flaps – as required (Full down recommended)
- (5) Alternator, Main Bus and Battery switch – OFF
- (6) Cabin Doors – unlock before touch-down
- (7) Touch-down – slightly nose up attitude
- (8) Brake firmly

◆ **Note:** Gliding Distance. Refer to “Maximum Glide” in the approved Pilot’s Operating Handbook.

FLIGHT IN ICING CONDITIONS

▲ **WARNING:** It is prohibited to fly in known icing conditions.

In case of inadvertent icing encounter proceed as follows:

- (1) Pitot Heat switch – ON (if installed)
- (2) Turn back or change the altitude to obtain an outside air temperature that is less conducive to icing.
- (3) Pull the cabin heat control full out and open defroster outlets to obtain maximum windshield defroster airflow. Adjust cabin air control to get maximum defroster heat and airflow.
- (4) Advance the Thrust Lever to increase the propeller speed and keep ice accumulation on the propeller blades as low as possible.
- (5) Watch for signs of air filter icing and pull the "Alternate Air Door" control if necessary. An unexplained loss in engine power could be caused by ice blocking the air intake filter. Opening the "Alternate Air Door" allows preheated air from the engine compartment to be aspirated.
- (6) Plan a landing at the nearest airfield. With an extremely rapid ice build up, select a suitable "off airfield" landing site.
- (7) With an ice accumulation of 0.5 cm or more on the wing leading edges, a significantly higher stall speed should be expected.
- (8) Leave wing flaps retracted. With a severe ice build up on the horizontal tail, the change in wing wake airflow direction caused by wing flap extension could result in a loss of elevator effectiveness.
- (9) Perform a landing approach using a forward slip, if necessary, for improved visibility.
- (10) Approach at 65 to 75 KIAS depending upon the amount of the accumulation.
- (11) Perform a landing in level attitude.

RECOVERY FROM SPIRAL DIVE

If a spiral is encountered in the clouds, proceed as follows:

- (1) Retard Thrust Lever to idle position
- (2) Stop the turn by using coordinated aileron and rudder control to align the symbolic airplane in the turn coordinator with the horizontal reference line.
- (3) Cautiously apply elevator back pressure to slowly reduce the airspeed to .
- (4) Adjust the elevator trim control to maintain anglide.
- (5) Keep hands off the control wheel, using rudder control to hold a straight heading.
- (6) Readjust the rudder trim (if installed) to relieve the rudder of asymmetric forces.
- (7) Clear the engine occasionally, but avoid using enough power to disturb the trimmed glide.
- (8) Upon breaking out of clouds, resume normal cruising flight and continue the flight.

ELECTRICAL POWER SUPPLY SYSTEM MALFUNCTIONS

- ▲ **WARNING:** If the power supply from both alternator and main battery is interrupted, continued engine operation is dependent on the remaining capacity of the FADEC backup battery. The engine has been demonstrated to continue operating for a maximum of 30 minutes when powered by the FADEC backup battery only. In this case, all electrical equipment will not operate:
- land as soon as possible
 - do not switch the FORCE-B switch, this will shut down the engine
-

- **CAUTION:** The TAE 125-02-114 requires an electrical power source for its operation. If the alternator fails, continued engine operation time is dependent upon the remaining capacity of the main battery, the FADEC backup battery and equipment powered. The engine has been demonstrated to continue operating for approximately 120 minutes based upon the following assumptions:
-

- **CAUTION:** This table only gives a reference point. The pilot should turn off all nonessential items and supply power only to equipment which is absolutely necessary for continued flight depending upon the situation.

Deviating from this recommendation, the remaining engine operating time may change.

Equipment		Time switched on	
		in [min]	in [%]
NAV/COM 1 receiving	ON	120	100
NAV/COM 1 transmitting	ON	12	10
NAV/COM 2 receiving	OFF	0	0
NAV/COM 2 transmitting	OFF	0	0
Annunciator	ON	120	100
Transponder	ON	120	100
Fuel Pump	OFF	0	0
AED-125	ON	120	100
Battery	ON	120	100
CED-125	ON	120	100
Landing Light	ON	12	10
Flood Light	ON	1.2	1
Pitot Heat	ON	24	20
Wing Flaps	ON	1.2	1
Interior Lighting	OFF	0	0
Nav Lights	OFF	0	0
Beacon	OFF	0	0
Strobes	OFF	0	0
ADF	OFF	0	0
Intercom	OFF	0	0
Engine Control	ON	120	100

Table 3-1a

Emergency Procedures Check List

ALTERNATOR WARNING DURING NORMAL ENGINE OPERATION

- (1) Ammeter – CHECK
- (2) Alternator switch CHECK – ON
- (3) Battery Switch CHECK – ON

■ **CAUTION:** If the FADEC was supplied by battery only until this point, the RPM can momentarily drop, when the alternator will be switched on. In any case: leave the alternator switched ON!

- (4) Electrical load – REDUCE IMMEDIATELY as follows:
 - i) Avionics Bus 2 / NAV/COM 2 – OFF
 - ii) Fuel Pump – OFF
 - iii) Landing Light – OFF (use as required for landing)
 - iv) Taxi Light – OFF
 - v) Strobe Light – OFF
 - vi) Nav Lights – OFF
 - vii) Beacon – OFF
 - viii) Interior Lights – OFF
 - ix) Intercom – OFF
 - x) Pitot Heat – OFF (use as required)
 - xi) Autopilot – OFF
 - xii) Non-essential equipment – OFF
- (5) The pilot should:
 - i) Land as soon as possible.
 - ii) Be prepared for an emergency landing.
 - iii) Expect an engine failure.

AMMETER SHOWS BATTERY DISCHARGE DURING
NORMAL ENGINE OPERATION FOR MORE THAN
5 MINUTES

- (1) Alternator switch CHECK – ON
- (2) Battery Switch CHECK – ON

■ CAUTION: If the FADEC was supplied by battery only until this point, the RPM can momentarily drop, when the alternator will be switched on. In any case: leave the alternator switched ON!

-
- (3) Electrical load – REDUCE IMMEDIATELY as follows:

- i) Avionics Bus 2 / NAV/COM 2 – OFF
- ii) Fuel Pump – OFF
- iii) Landing Light – OFF (use as required for landing)
- iv) Taxi Light – OFF
- v) Strobe Light – OFF
- vi) Nav Lights – OFF
- vii) Beacon – OFF
- viii) Interior Lights – OFF
- ix) Intercom – OFF
- x) Pitot Heat – OFF (use as required)
- xi) Autopilot – OFF
- xii) Non-essential equipment – OFF

- (4) The pilot should:

- i) Land as soon as possible
- ii) Be prepared for an emergency landing
- iii) Expect an engine failure

TOTAL ELECTRICAL FAILURE

(all equipment inoperative, except engine)

▲ **WARNING:** If the power supply from both alternator and main battery is interrupted simultaneously, continued engine operation is dependent on the remaining capacity of the FADEC backup battery. The engine has been demonstrated to continue operating for a maximum of 30 minutes when powered by the FADEC backup battery only. In this case, all other electrical equipment will not operate.

▲ **WARNING:** If the aircraft was operated on battery power only until this point (alternator warning light illuminated), the remaining engine operating time may be less than 30 minutes.

▲ **WARNING:** Do not activate the FORCE-B switch, this will shut down the engine.

-
- (1) Alternator switch CHECK – ON
 - (2) Battery Switch CHECK – ON
 - (3) Land as soon as possible
 - i) Be prepared for an emergency landing
 - ii) Expect an engine failure

ROUGH ENGINE OPERATION OR LOSS OF POWER

DECREASE IN POWER

- (1) Push Thrust Lever full forward (Take-off position)
- (2)
- (3) Electric Fuel Pump – ON
- (4) Reduce airspeed to 65-85 KIAS (best glide recommended),
(max. 100 KIAS)
- (5) Check engine parameters (FADEC lights, oil pressure and
temperature, fuel quantity)

If normal engine power is not achieved, the pilot should:

- i) Land as soon as possible
- ii) Be prepared for an emergency landing
- iii) Expect an engine failure

▲ WARNING: The high pressure pump must be checked by an authorized service center before the next flight.

OIL PRESSURE TOO LOW (< 2.3 BAR IN CRUISE (AMBER RANGE) OR < 1.2 BAR AT IDLE (RED RANGE)):

- (1) Reduce power as quickly as possible
- (2) Check oil temperature: If the oil temperature is high or near operating limits,
 - i) Land as soon as possible
 - ii) Be prepared for an emergency landing
 - iii) Expect an engine failure

◆ Note: During warm-weather operation or long climbs at low airspeed engine temperatures could rise into the amber range and trigger the "Caution" light. This indication allows the pilot to avoid overheating of the engine as follows:

- (3) Increase the climbing airspeed, reduce angle of climb
- (4) Reduce power, if the engine temperatures approach the red range

OIL TEMPERATURE TOO HIGH (RED RANGE):

- (1) Increase airspeed and reduce power as quickly as possible
- (2) Check oil pressure: if the oil pressure is lower than normal (< 2.3 bar in cruise or < 1.2 bar at idle),
 - i) Land as soon as possible
 - ii) Be prepared for an emergency landing
 - iii) Expect an engine failure
- (3) If the oil pressure is in the normal range:
 - i) Land as soon as possible

COOLANT TEMPERATURE TOO HIGH (RED RANGE):

- (1) Increase airspeed and reduce power as quickly as possible
- (2) Cabin Heat – COLD
- (3) If coolant temperature reduces rapidly to normal range, continue to fly normally and monitor coolant temperature, Cabin Heat.
- (4) If coolant temperature does not decrease,
 - i) Land as soon as possible
 - ii) Be prepared for an emergency landing
 - iii) Expect an engine failure

"WATER LEVEL" LIGHT ILLUMINATES/Caution COOL LVL

- (1) Increase airspeed and reduce power as quickly as possible
- (2) Coolant temperature "CT" check and observe
- (3) Oil temperature "OT" check and observe
- (4) If coolant temperature and/or oil temperature are rising into amber or red range,
 - i) Land as soon as possible
 - ii) Be prepared for an emergency landing
 - iii) Expect an engine failure

GEARBOX TEMPERATURE TOO HIGH (RED RANGE):

- (1) Reduce power to 55% - 75% as quickly as possible
- (2) Land as soon as possible

FUEL TEMPERATURE TOO HIGH:

- (1) Switch to fuel tank with lower fuel temperature, if this contains sufficient fuel
- (2) Reduce engine power, if possible
- (3) If fuel temperature remains in Red Range, land as soon as possible

FUEL TEMPERATURE TOO LOW (AMBER RANGE for Diesel Operation, RED RANGE for Kerosine Operation):

- (1) Switch to fuel tank with higher fuel temperature, if this contains sufficient fuel
- (2) Change to altitude with higher outside air temperature
- (3) If use of the non-active tank is intended, switch fuel selector to BOTH

◆ Note: Low fuel temperature may be caused when flying in cold weather with fuel cooler in operation (baffle removed).

PROPELLER RPM TOO HIGH:

With propeller RPM between 2,400 and 2,500 for more than 10 seconds or over 2,500:

- (1) Reduce power
- (2) Reduce airspeed below 100 KIAS or as appropriate to prevent propeller overspeed
- (3) Set power as required to maintain altitude and land as soon as possible.

◆ Note: If the propeller speed control fails, climbs be performed at 65 KIAS and a power setting of 100%.
In case of overspeed the FADEC will reduce the engine power at higher airspeeds to avoid propeller speeds above 2500 rpm.

FLUCTUATIONS IN PROPELLER RPM:

If the propeller RPM fluctuates by more than + / - 100 RPM with a constant Thrust Lever position:

- (1) Change the power setting and attempt to find a power setting where the propeller RPM no longer fluctuates.
- (2) If this does not work, set the maximum power at an airspeed < 100 KIAS until the propeller speed stabilizes.
- (3) If the problem is resolved, continue the flight
- (4) If the problem continues, select a power setting where the propeller RPM fluctuations are minimum. Fly at an airspeed below 100 KIAS and land as soon as possible.

SECTION 4 NORMAL PROCEDURES

PREFLIGHT INSPECTION

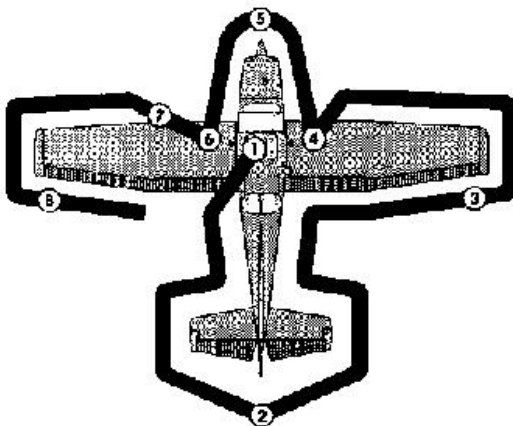

Figure 4-1a Preflight Inspection

-
- ◆ Note: Visually check airplane for general condition during walk around inspection. In cold weather, remove even small accumulations of frost, ice or snow from wing, tail and control surfaces. Also, make sure that control surfaces contain no internal accumulations of ice or debris. Prior to flight, check that pitot heater (if installed) is warm to touch within 30 seconds with battery and pitot heat switches on. If a night flight is planned, check operation of all lights, and make sure a flashlight is available.
-

This page intentionally left blank

SECTION 4a NORMAL PROCEDURES (with CED/AED Engine Instruments)

-
- ◆ Note: This chapter applies to aircraft installations **with CED/AED Engine Instruments** configuration.
The chapter not relevant to the respective configuration can be omitted.
-

(1) CABIN

- (1) Pitot Tube Cover – REMOVE. Check for pitot blockage
- (2) Pilot’s Operating Handbook – AVAILABLE IN THE AIRPLANE
- (3) Airplane Weight and Balance – CHECKED
- (4) Parking Brake – SET
- (5) Control Wheel Lock – REMOVE
- (6) "Engine Master" – OFF
- (7) Avionics Master Switch – OFF

▲ WARNING: When turning on the Battery switch, using an external power source, or pulling the propeller through by hand, treat the propeller as if the Engine Master was on.

- (8) Battery – ON
- (9) Fuel Quantity Indicators and Fuel Temperature – CHECK and ENSURE LOW FUEL ANNUNCIATORS (L LOW FUEL R) ARE EXTINGUISHED
- (10) Light “Water Level“ – CHECK OFF
- (11) Avionics Master Switch – ON, CHECK Avionics Cooling Fan audibly for operation
- (12) Avionics Master Switch – OFF
- (13) Static Pressure Alternate Source Valve – OFF
- (14) Annunciator Panel Test Switch – PLACE AND HOLD IN TST POSITION and ensure all annunciators illuminate
- (15) Annunciator Panel Test Switch – RELEASE. Check that appropriate annunciators remain on.

◆ Note: When Battery is turned ON, some annunciators will flash for about 10 seconds before illuminating steadily. When panel TST switch is toggled up and held in position, all remaining lights will flash until the switch is released.

-
-
- (16) Fuel Selector Valve – BOTH (Check fuel temperature)
 - (17) Fuel Shut-off Valve – ON (Push Full In)
 - (18) Shut-off Cabin Heat – OFF (Push Full Forward)
 - (19) Flaps – EXTEND
 - (20) Pilot Heat – ON (Carefully check that the pilot tube is warm to the touch within 30 seconds)
 - (21) Pilot Heat – OFF
 - (22) Battery – OFF
 - (23) Baggage Door – CHECK, lock with key

(2) EMPENNAGE

- (1) Rudder Gust Lock (if attached) – REMOVE
- (2) Tail Tie-Down – DISCONNECT
- (3) Control Surfaces – CHECK freedom of movement and security
- (4) Trim Tab – CHECK security
- (5) Antennas – CHECK for security of attachment and general condition

(3) RIGHT WING Trailing Edge

- (1) Aileron – CHECK freedom of movement and security
- (2) Flap – CHECK for security and condition

(4) RIGHT WING

- (1) Wing Tie-Down – DISCONNECT
- (2) Main Wheel Tire – CHECK for proper inflation and general condition (weather checks, tread depth and wear, etc.).

▲ **WARNING:** If, after repeated sampling, evidence of contamination still exists, the airplane should not be flown. Tanks should be drained and system purged by qualified maintenance personnel. All evidence of contamination must be removed before further flight.

- (3) Fuel Tank Sump Quick Drain Valves (5) – DRAIN at least a cupful of fuel (using sampler cup) from each sump location to check for water, sediment and the right type of fuel (Diesel or JET-A1) before each flight and after each refueling. If water is observed, take further samples until clear and then gently rock wings and lower tail to the ground to move any additional contaminants to the sampling points. Take repeated samples from all fuel drain points until all contamination has been removed. If contaminants are still present, refer to above WARNING and do not fly airplane.
- (4) Fuel Quantity – CHECK VISUALLY for desired level not above marking in fuel filler
- (5) Fuel Filler Cap – SECURE and VENT CLEAR

(5) NOSE

- (1) Reservoir tank Quick Drain Valve – DRAIN at least a cupful of fuel (using sampler cup) from valve to check for water, sediment and proper fuel grade (Diesel or JET-A1) before each flight and after each refueling. If water is observed, take further samples until clear and then gently rock wings and lower tail to the ground to move any additional contaminants to the sampling point. Take repeated samples until all contamination has been removed.

◆ Note: The reservoir tank drain is located in the fuselage on the co-pilot side of the aircraft.

- (2) Before first flight of the day and after each refueling – DRAIN the Fuel Strainer Quick Drain Valve with the sampler cup to remove water and sediment from the screen. Ensure that the screen drain is properly closed again. If water is discovered, there might be even more water in the fuel system. Therefore, take further samples from Fuel Strainer and the Tank Sumps.

◆ Note: The fuel strainer drain is located on the left-hand side of the firewall (flight direction).

- (3) Engine Oil Dipstick/Filler Cap:
 - a) Oil level – CHECK
 - b) Dipstick/filler cap – SECUREDo not operate below the minimum dipstick indication.
- (4) Engine Air and Cooling Inlets – CLEAR of obstructions.
- (5) Propeller and Spinner – CHECK for nicks and security.
- (6) Gearbox Oil Level – CHECK the oil has to cover at least half of the inspection glass
- (7) Nose Wheel Strut and Tire – CHECK for proper inflation of strut and general condition (weather checks, tread depth and wear, etc.) of tire

-
-
- (8) Left Static Source Opening – CHECK for blockage
 - (9) Fuel cooler baffle – CHECK
 - REMOVE, if OAT on ground in higher than 20°C (68°F)
 - INSTALL, if OAT on ground in lower than 20°C (68°F)

(6) LEFT WING

- (1) Fuel Quantity – CHECK VISUALLY for desired level not above marking in fuel filler
- (2) Fuel Filler Cap – SECURE
- (3) Fuel Tank Sump Quick Drain Valves (5) – DRAIN at least a cupful of fuel (using sampler cup) from each sump location to check for water, sediment and the right type of fuel (Diesel or JET-A1) before each flight and after each refueling. If water is observed, take further samples until clear and then gently rock wings and lower tail to the ground to move any additional contaminants to the sampling points. Take repeated samples from all fuel drain points until all contamination has been removed. If contaminants are still present, refer to previous WARNING (see right wing) and do not fly airplane.
- (4) Main Wheel Tire – CHECK for proper inflation and general condition (weather checks, tread depth and wear, etc.)

(7) LEFT WING Leading Edge

- (1) Fuel Tank Vent Opening – CHECK for blockage
- (2) Stall Warning Opening – CHECK for blockage
- (3) Wing Tie-Down – DISCONNECT
- (4) Landing/Taxi Light(s) – CHECK for condition and cleanliness of cover

(8) LEFT WING Trailing Edge

- (1) Aileron – CHECK freedom of movement and security
- (2) Flap – Check for security and conditions

BEFORE STARTING ENGINE

- (1) Preflight Inspection – COMPLETE
- (2) Passenger Briefing – COMPLETE
- (3) Seats and Seat Belts – ADJUST and LOCK Ensure inertia reel locking.
- (4) Brakes – TEST
- (5) Circuit Breakers – CHECK IN
- (6) Electrical Equipment, Autopilot (if installed) – OFF.

■ **CAUTION:** The Avionics Power Switch must be off during engine start to prevent possible damage to avionics.

- (7) Avionics Master Switch – OFF
- (8) Circuit Breakers – CHECK IN
- (9) Avionics Circuit Breakers – CHECK IN
- (10) Switch Alternator – CHECK ON
- (11) Battery – ON

■ **CAUTION:** The electronic engine control needs an electrical power source for its operation. For normal operation Battery, Alternator and Main Bus have to be switched on. Separate switching is only allowed for tests and in the event of emergencies.

- (12) Fuel Quantity and Temperature – CHECK
- (13) Fuel Selector Valve – SET to BOTH position. The fuel temperature limitations must be observed.
- (14) Fuel Shut-off Valve – OPEN (Push Full In)
- (15) Alternate Air Door – CLOSED
- (16) Thrust Lever – CHECK for freedom of movement
- (17) Load Display – CHECK 0% at Propeller RPM 0

PROCEDURES UP TO 5500ft AIRFIELD ELEVATION

STARTING ENGINE

▲ **WARNING:** Do not use ground power unit for engine starts. It is not allowed to start up the engine using external power. If starting the engine is not possible using battery power, the condition of the battery must be verified before flight.

- (1) Electric Fuel Pump – ON
 - (2) Navigation Lights and Flashing Beacon – ON (as required).
 - (3) Thrust Lever – IDLE
 - (4) Area Aircraft / Propeller – CLEAR
 - (5) Engine Master – ON, wait until the Glow Control light extinguishes
 - (6) Starter – ON, keep starter engaged until min. 500rpm
Release when engine starts, leave Thrust Lever in idle
-

■ **CAUTION:** Do not overheat the starter motor. Do not operate the starter motor for more than 10 seconds. After operating the starter motor, let it cool off for 20 seconds. After 6 attempts to start the engine, let the starter cool off for half an hour.

- (7) Oil Pressure – CHECK
-

■ **CAUTION:** If after 3 seconds the minimum oil pressure of 1 bar is not indicated:
shut down the engine immediately!

- (8) CED Test Knob – PRESS (to delete Caution light)
- (9) Ammeter – CHECK for positive charging current
- (10) Voltmeter – CHECK for green range

-
-
- (11) FADEC Backup Battery test
- Alternator – OFF, engine must operate normally
 - Battery – OFF, for min. 10 seconds;
engine must operate normally, the red FADEC lamps
must not be illuminated
 - Battery – ON
 - Alternator – ON

▲ **WARNING:** It must be ensured that both battery and
alternator are ON!
If the guarded alternator switch is installed,
the switch guard must be closed.

- (12) Avionics Power Switch – ON
(13) Radios – ON
(14) Ammeter – Check positive charge, alternator warning light
must be OFF
(15) Voltmeter – Check in green range
(16) Electric Fuel Pump – OFF
(17) Flaps – RETRACT

WARM UP

- Let the engine warm up about 2 minutes at 890 RPM.
- Increase RPM to 1,400 until Oil Temperature 50°C (122°F),
Coolant Temperature 60°C (140°F).

BEFORE TAKE-OFF

- Parking Brake – SET
- Passenger Seat Backs – MOST UPRIGHT POSITION
- Seats and Seat Belts – CHECK SECURE
- Cabin Doors and Windows – CLOSED and LOCKED
- Flight Controls – FREE and CORRECT
- Flight Instruments – CHECK and SET
- Fuel quantity – CHECK
- Fuel Selector Valve – SET to BOTH
- Elevator Trim and Rudder Trim (if installed) – SET for
Takeoff

-
-
- (10) FADEC and propeller adjustment function check:
- a) Thrust Lever – IDLE (both FADEC lights should be OFF)
 - b) FADEC Test Button – PRESS and HOLD button for entire test
 - c) Both FADEC lights – ON, RPM increases

▲ **WARNING:** If the FADEC lights do not come on at this point, it means that the test procedure has failed and take off should not be attempted.

- d) The FADEC automatically switches to B-component (only FADEC B light is ON)
- e) The propeller control is excited, RPM decreases
- f) The FADEC automatically switches to channel A (only FADEC A light is ON), RPM increases
- g) The propeller control is excited, RPM decreases
- h) FADEC A light goes OFF, idle RPM is reached, the test is completed.
- i) FADEC Test Button – RELEASE

(11) Force B Switch – switch to FADEC B

(12) Engine – check running without a change

(13) Force B Switch – switch back to Automatic

▲ **WARNING:** If there are prolonged engine misfires or the engine shuts down during the test, take off may not be attempted.

▲ **WARNING:** The whole test procedure has to be performed without any failure. In case the engine shuts down or the FADEC lights are flashing, take off is prohibited. This applies even if the engine seems to run without failure after the test.

◆ **Note:** If the test button is released before the self test is over, the FADEC immediately switches over to normal operation.

◆ Note: While switching from one FADEC to another, it is normal to hear and feel a momentary surge in the engine.

- (14) Thrust Lever – FULL FORWARD, load display min. 94%, RPM 2240 - 2300
- (15) Thrust Lever – IDLE
- (16) Engine Instruments and Ammeter – CHECK
- (17) Suction gage – CHECK
- (18) Annunciator Panel – Ensure no annunciators are illuminated.
- (19) Wing Flaps – SET for Take-off (0° or 10°).
- (20) Electric Fuel Pump – ON
- (21) Strobe Lights – AS DESIRED
- (22) Radios and Avionics – ON and SET
- (23) Autopilot (if installed) – OFF
- (24) Air Conditioning (if installed) – OFF
- (25) Thrust Lever Friction Control – ADJUST
- (26) Brakes – RELEASE

PROCEDURES OVER 5500ft AIRFIELD ELEVATION

- ◆ **Note:** Due to the increase of the idle speed with increasing pressure altitudes, the FADEC test is only possible to a limited extent from an airfield elevation of approximately 5500ft.
- Over 5500ft, the FADEC test is only possible if the load selector lever remains in the idle position after engine start until the FADEC test is starting.
- If the load selector lever is moved from the idle position, a FADEC test is no longer possible at pressure altitudes above 5500ft. For this purpose, the engine has to be stopped and re-started to perform the FADEC test.

STARTING ENGINE

- ▲ **WARNING:** Do not use ground power unit for engine starts. It is not allowed to start up the engine using external power. If starting the engine is not possible using battery power, the condition of the battery must be verified before flight.

-
- (1) Electric Fuel Pump – ON
 - (2) Navigation Lights and Flashing Beacon - ON (as required)
 - (3) Thrust Lever – IDLE
 - (4) Area Aircraft / Propeller – CLEAR
 - (5) "Engine Master" – ON, wait until the Glow Control light extinguishes
 - (6) Starter – ON, keep starter engaged until min. 500rpm
Release when engine starts, leave Thrust Lever in idle

-
- **CAUTION:** Do not overheat the starter motor. Do not operate the starter motor for more than 10 seconds. After operating the starter motor, let it cool off for 20 seconds. After 6 attempts to start the engine, let the starter cool off for half an hour.
-

(7) Oil Pressure – CHECK

- **CAUTION:** If after 3 seconds the minimum oil pressure of 1 bar is not indicated: shut down the engine immediately!
-

(8) CED-Test Knob – PRESS (to delete Caution light)

(9) Ammeter – CHECK for positive charging current

(10) Voltmeter – CHECK for green range

(11) FADEC Backup Battery test

- a) Alternator – OFF, engine must operate normally
 - b) Battery – OFF, for min. 10 seconds; engine must operate normally, the red FADEC lamps must not be illuminated
 - c) Battery – ON
 - d) Alternator – ON
-

- ▲ **WARNING:** It must be ensured that both battery and alternator are ON!
If the guarded alternator switch is installed, the switch guard must be closed.
-

(12) Ammeter – Check positive charge, alternator warning light must be OFF

(13) Voltmeter – Check in green range

(14) Flaps – RETRACT

WARM UP AND FADEC-TEST

- (1) Let the engine warm up about 2 minutes at 890 RPM.
- (2) Increase RPM to 1,400 until Oil Temperature 50°C, Coolant Temperature 60°C.
- (3) Thrust Lever - IDLE
- (4) "Engine Master" - OFF
- (5) Area Aircraft / Propeller - CLEAR
- (6) "Engine Master" - ON, wait until the Glow Control light extinguishes
- (7) Starter - ON, keep starter engaged until min. 500rpm
Release when engine starts, leave Thrust Lever in idle
- (8) Ammeter - CHECK for positive charging current
- (9) Voltmeter - CHECK for green range
- (10) FADEC and propeller adjustment function check:
 - a) Thrust Lever – IDLE (both FADEC lights should be OFF)
 - b) FADEC Test Button – PRESS and HOLD button for entire test.
 - c) Both FADEC lights – ON, RPM increases

▲ WARNING: If the FADEC lights do not come on at this point, it means that the test procedure has failed and take off should not be attempted.

- d) The FADEC automatically switches to B-component (only FADEC B light is ON)
 - e) The propeller control is excited, RPM decreases
 - f) The FADEC automatically switches to channel A (only FADEC A light is ON), RPM increases
 - g) The propeller control is excited, RPM decreases
 - h) FADEC A light goes OFF, idle RPM is reached, the test is completed.
 - i) FADEC Test Button – RELEASE
- (11) Force B Switch – switch to FADEC B
 - (12) Engine – check running without a change
 - (13) Force B Switch – switch back to Automatic

▲ **WARNING:** If there are prolonged engine misfires or the engine shuts down during the test, take off may not be attempted.

▲ **WARNING:** The whole test procedure has to be performed without any failure. In case the engine shuts down or the FADEC lights are flashing, take off is prohibited. This applies even if the engine seems to run without failure after the test.

◆ **Note:** If the test button is released before the self test is over, the FADEC immediately switches over to normal operation.

◆ **Note:** While switching from one FADEC to another, it is normal to hear and feel a momentary surge in the engine.

- (14) Avionic Switch – ON
- (15) Radios – ON
- (16) Electric Fuel Pump – OFF

BEFORE TAKE-OFF

- (1) Parking Brake – SET
- (2) Passenger Seat Backs – MOST UPRIGHT POSITION
- (3) Seats and Seat Belts – CHECK SECURE
- (4) Cabin Doors and Windows – CLOSED and LOCKED
- (5) Flight Controls – FREE and CORRECT
- (6) Flight Instruments – CHECK and SET
- (7) Fuel quantity – CHECK
- (8) Fuel Selector Valve – SET to BOTH position if this option is installed.
- (9) Elevator Trim and Rudder Trim (if installed) – SET for Takeoff

- (10) Thrust Lever – FULL FORWARD, load display min. 94%, RPM 2240 - 2300
- (11) Thrust Lever – IDLE
- (12) Engine Instruments and Ammeter – CHECK
- (13) Suction gage – CHECK
- (14) Annunciator Panel – Ensure no annunciators are illuminated
- (15) Wing Flaps – SET for Take-off (0° or 10°).
- (16) Electric Fuel Pump – ON
- (17) Strobe Lights – AS DESIRED
- (18) Radios and Avionics – ON and SET
- (19) Autopilot (if installed) – OFF
- (20) Air Conditioning (if installed) – OFF
- (21) Thrust Lever Friction Control – ADJUS
- (22) Brakes – RELEASE

TAKE-OFF

NORMAL TAKEOFF

- (1) Wing Flaps – 0° or 10°
- (2) Thrust Lever – FULL FORWARD
- (3) Elevator Control – LIFT NOSE WHEEL at 55 KIAS.
- (4) Climb Speed – 65 to 80 KIAS

SHORT FIELD TAKEOFF

- (1) Wing Flaps – 10°
- (2) Brakes – APPLY
- (3) Thrust Lever – FULL FORWARD
- (4) Brakes – RELEASE
- (5) Elevator Control – SLIGHTLY TAIL LOW
- (6) Elevator Control – LIFT NOSE WHEEL at 51 KIAS
- (7) Climb Speed – 57 KIAS (until all obstacles are cleared)

AFTER TAKEOFF

- (1) Altitude about 300 ft, Airspeed more than 65 KIAS – Wing Flaps – RETRACT
- (2) Electric Fuel Pump – OFF

CLIMB

- (1) Airspeed – 70 to 85 KIAS.

◆ Note: If a maximum performance climb is necessary, use speeds shown in the "Maximum Rate Of Climb" chart in Section 5. In case that Oil Temperature and/or Coolant Temperature are approaching the upper limit, continue at a lower climb angle for better cooling if possible.

◆ Note: It is recommended to set the fuel selector valve to the BOTH position. The fuel temperatures have to be monitored.

- (2) Thrust Lever – FULL FORWARD

CRUISE

- (1) Power – maximum load 100% (maximum continuous power), 75% or less is recommended.
For economic cruise set load 70% or less.
- (2) Elevator trim – ADJUST
- (3) Compliance with Limits for Oil Pressure, Oil Temperature, Coolant Temperature and Gearbox Temperature (CED 125 and Caution light) – MONITOR closely
- (4) Fuel Quantity and Temperature (Display and LOW LEVEL caution lights) – MONITOR

Whenever possible, the airplane should be flown with the fuel selector in the BOTH position to empty and heat both fuel tanks evenly. However, operation in the LEFT or RIGHT position may be desirable to correct a fuel quantity imbalance or during periods of intentional uncoordinated flight manoeuvres. During prolonged operation with the fuel selector in either the LEFT or RIGHT position the fuel balance and temperatures should be closely monitored.

■ CAUTION: Do not use any fuel tank below the minimum permissible fuel temperature!

■ CAUTION: In turbulent air it is strongly recommended to use the BOTH position.

■ CAUTION: With $\frac{1}{4}$ tank or less prolonged or uncoordinated flight is prohibited when operating on either the left or right tank.

- (5) FADEC and Alternator Warning lights – MONITOR

DESCENT

- (1) Fuel Selector Valve – SELECT BOTH position
- (2) Power – AS DESIRED

BEFORE LANDING

- (1) Pilot and Passenger Seat Backs – MOST UPRIGHT POSITION
- (2) Seats and Seat Belts – SECURED and LOCKED
- (3) Fuel Selector Valve – SELECT BOTH position
- (4) Electric Fuel Pump – ON
- (5) Landing / Taxi Lights – ON
- (6) Autopilot (if installed) – OFF
- (7) Air Conditioning (if installed) – OFF

LANDING

NORMAL LANDING

- (1) Airspeed – 69 to 80 KIAS (wing flaps UP)
- (2) Wing Flaps – AS DESIRED (0°-10° below 110 KIAS; 10°– below 85 KIAS)
- (3) Airspeed – 60 to 70 KIAS (Flaps DOWN)
- (4) Touchdown – MAIN WHEELS FIRST
- (5) Landing Roll – LOWER NOSE WHEEL GENTLY
- (6) Brakes – MINIMUM REQUIRED

SHORT FIELD LANDING

- (1) Airspeed – 69 to 80 KIAS (Flaps UP)
- (2) Wing Flaps – FULL DOWN
- (3) Airspeed – 62 KIAS (until flare)
- (4) Power – REDUCE to idle after clearing obstacles.
- (5) Touchdown – MAIN WHEELS FIRST
- (6) Brakes – APPLY HEAVILY
- (7) Wing Flaps – RETRACT

BALKED LANDING

- (1) Thrust Lever – FULL FORWARD
- (2) Wing Flaps – RETRACT TO 20° (immediately after Thrust Lever FULL FORWARD)
- (3) Climb Speed – 58 KIAS
- (4) Wing Flaps – 10° (until all obstacles are cleared)
- (5) Wing Flaps – RETRACT after reaching a safe altitude and 65 KIAS

AFTER LANDING

- (1) Wing Flaps – RETRACT
- (2) Electric Fuel Pump – OFF

SECURING AIRPLANE

- (1) Parking Brake – SET
- (2) Thrust Lever – IDLE
- (3) Avionics Power Switch, Electrical Equipment, Autopilot (if installed) – OFF
- (4) "Engine Master" – OFF
- (5) Switch Battery – OFF
- (6) Control Lock – INSTALL
- (7) Fuel Selector Valve – LEFT or RIGHT (to prevent crossfeeding between tanks)

AMPLIFIED PROCEDURES

STARTING ENGINE

The TAE 125-02-114 is a direct Diesel injection engine with common-rail technology and a turbocharger. It is controlled automatically by the FADEC, which makes a proper performance of the FADEC test important for safe flight operation. All information relating to the engine are compiled in the CED 125 multifunction instrument.

Potentiometers within the Thrust Lever transmit the load value selected by the pilot to the FADEC.

If the engine master is switched to ON, the preheating relay is actuated by the FADEC and the glow plugs are supplied with power. The glow duration depends on the engine temperature. If the engine master is switched to OFF, the injection valves are not supplied with power and remain closed.

The switch "Starter" controls the Starter.

EXTERNAL POWER

External power may be used to charge the battery or for maintenance purposes. Refer to original instructions.

It is not allowed to start up the engine using external power. If starting the engine is not possible using battery power, the condition of the battery must be verified before flight.

TAXIING

When taxiing, it is important that speed and use of brakes be held to a minimum and that all controls be utilized to maintain directional control and balance.

The Alternate Air Door should be always for ground operation to ensure that no unfiltered air is sucked in.

Taxiing over loose gravel or cinders should be done at low engine speed to avoid abrasion and stone damage to the propeller tips.

BEFORE TAKE-OFF

WARM UP

To warm up the engine, operate the engine for about 2 minutes at 890 RPM.

Let the engine run at propeller RPM of 1,400 until it reaches an engine oil temperature of 50°C (green range) and a coolant temperature of 60°C (green range to ensure normal operation).

MAGNETO CHECK

N/A

ALTERNATOR CHECK

Prior to flights where verification of proper alternator and alternator control unit operation is essential (such as night and instrument flights), a positive verification can be made by loading the electrical system momentarily (3 to 5 seconds) with the landing light or by operating the wing flaps during the engine runup (20% load). The ammeter will remain within a needle width of zero if the alternator and alternator control unit are operating properly.

BATTERY CHECK

If there is doubt regarding the battery conditions or functionality the battery has to be checked after warm-up as follows:

Switch off the alternator while the engine is running (battery remains "ON")

Perform a 10 sec. engine run. The voltmeter must remain in the green range. If not, the battery has to be charged or, if necessary, exchanged.

After this test the alternator has to be switched on again.

TAKE-OFF

POWER CHECK

It is important to check full load engine operation early in the takeoff roll. Any signs of rough engine operation or sluggish engine acceleration is good cause for discontinuing the take-off. If this occurs, you are justified in making a thorough full load static runup before another take-off is attempted.

After full load is applied, adjust the Thrust Lever Friction Control to prevent the Thrust Lever from creeping back from a maximum power position. Similar friction lock adjustments should be made as required in other flight conditions to maintain a fixed Thrust Lever setting.

WING FLAP SETTINGS

Flap deflections greater than 10° are not approved for normal and short field takeoffs. Using 10° wing flaps reduces the ground roll and total distance over a 15 m obstacle by approximately 10%.

CLIMB

Normal climbs are performed with flaps up and full load and at speeds 5 to 10 knots higher than best rate-of-climb speeds for the best combination of engine cooling, climb speed and visibility. The speed for best climb is about 70 KIAS. If an obstruction dictates the use of a steep climb angle, climb at 62 KIAS and flaps up.

◆ Note: Climbs at low speeds should be of short duration to improve engine cooling.

CRUISE

As guidance for calculation of the optimum altitude and power setting for a given flight use the tables in chapter 5.

LANDING

BALKED LANDING

In a bailed landing (go around) climb, reduce the flap setting to 20° immediately after full power is applied. If obstacles must be cleared during the go-around climb, reduce wing flap setting to 10° and maintain a safe airspeed until the obstacles are cleared. After clearing any obstacles, the flaps may be retracted as the airplane accelerates to the normal flaps up climb speed.

COLD WEATHER OPERATION

Special attention should be paid to operation of the aircraft and the fuel system in winter or before any flight at low temperatures. Correct preflight draining of the fuel system is particularly important and will prevent the accumulation of water.

The following limitations for cold weather operation are established due to temperature. "Operating limits".

(Refer Section 2 "Limitations" also)

Fuel	Minimum fuel temperature in the fuel tank before Take-off	Minimum fuel temperature in the fuel tank during the flight
JET A-1, JET A, Fuel No.3 JP-8, JP-8+100 TS-1	-30°C (-22°F)	-35°C (-31°F)
Diesel Sasol GTL Diesel	greater than 0°C(32°F)	-5°C (23°F)

Figure 4-1a Minimum fuel temperature limits in the fuel tank

▲ **WARNING:** The fuel temperature of the fuel tank not in use should be observed if it is intended for later use.

▲ **WARNING:** The following applies to Diesel and Jet fuel mixtures in the tank:
As soon as the proportion of Diesel in the tank is more than 10% Diesel, the fuel temperature limits have to be observed for Diesel operation. If there is uncertainty about the type of fuel in the tank, the assumption should be made that it is Diesel.

-
- ◆ Note: It is advisable to refuel before each flight and to enter the type of fuel filled and the additives used in the log-book of the airplane.
-

If snow or slush covers the take-off surface, allowance must be made for take-off distances which will be increasingly extended as snow or slush depth increases. The depth and consistency of this cover can, in fact, prevent take-off in many instances.

Cold weather starting procedures are the same as the normal starting procedures. Use caution to prevent inadvertent forward movement of the airplane during starting when parked on snow or ice.

HOT WEATHER OPERATION

Engine temperatures may rise into the amber range and activate the "Caution" light when operating in hot weather or longer climbouts at low speed. This indication gives the pilot the opportunity to keep the engine from possibly overheating by doing the following:

- i) decrease rate of climb
- ii) increase airspeed
- iii) reduce power, if the engine temperatures approach the red range

Should the seldom case occur that the fuel temperature is rising into the amber or red range, switch to the other tank or to the BOTH position.

SECTION 4b NORMAL PROCEDURES (G1000 with Engine Indication System)

-
- ◆ Note: This chapter applies to aircraft installations **with G1000 with Engine Indication System (without AED/CED)** configuration. The chapter not relevant to the respective configuration can be omitted.
-

(1) CABIN

- (1) Pitot Tube Cover – REMOVE (check for pitot blockage)
- (2) Pilot's Operating Handbook – ACCESSIBLE TO PILOT
- (3) Garmin G1000 Cockpit Reference Guide – ACCESSIBLE TO PILOT
- (4) Airplane Weight and Balance – CHECKED
- (5) Parking Brake – SET
- (6) Control Wheel Lock – REMOVE
- (7) Engine Master Switch – OFF
- (8) Avionics Switch (BUS 1 and BUS 2) – OFF

▲ WARNING: When turning on the Battery switch, using an external power source, or pulling the propeller through by hand, treat the propeller as if the Engine Master was on.

- (9) MASTER Switch (BAT) – ON
- (10) Primary Flight Display (PFD) – CHECK (Verify if PFD is ON)
- (11) FUEL QTY (L and R) – CHECK
- (12) LOW FUEL L and LOW FUEL R Annunciators – CHECK (verify annunciators are not shown on PFD)
- (13) LOW VACUUM Annunciator – CHECK (verify annunciator is shown)
- (14) AVIONICS Switch (BUS 1) – ON
- (15) Forward Avionics Fan – CHECK (verify fan is heard)
- (16) AVIONICS Switch (BUS 1) – OFF

- (17) AVIONICS Switch (BUS 2) – ON
- (18) Aft Avionics Fan – CHECK (verify fan is heard)
- (19) AVIONICS Switch (BUS 2) – OFF
- (20) PITOT HEAT Switch – ON (carefully check that pitot tube is warm to the touch within 30 seconds)
- (21) PITOT HEAT Switch – OFF

-
-
- (22) LOW VOLTS Annunciator – CHECK (verify annunciator is shown)
 - (23) MASTER Switch (BAT) – OFF
 - (24) Elevator Trim Control – TAKEOFF position
 - (25) FUEL SELECTOR Valve – BOTH
 - (26) ALT STATIC AIR Valve – OFF (push full in)
 - (27) Fire Extinguisher – CHECK (verify gage pointer in green arc)

(2) EMPENNAGE

- (1) Baggage Compartment Door – CHECK (lock with key)
- (2) Rudder Gust Lock (if installed) – REMOVE
- (3) Tail Tiedown – DISCONNECT
- (4) Control Surfaces – CHECK (freedom of movement and security)
- (5) Elevator Trim Tab – CHECK (security)
- (6) Antennas – CHECK (security of attachment and general condition)

(3) RIGHT WING Trailing Edge

- (1) Flap – CHECK (security and condition)
- (2) Aileron – CHECK (freedom of movement and security)

(4) RIGHT WING

- (1) Landing/Taxi (Light(s) – CHECK (condition and cleanliness of cover) (If installed)
- (2) Wing Tiedown – DISCONNECT
- (3) Main Wheel Tire – CHECK (proper inflation and general condition (weather checks, tread depth and wear, etc.))

-
- (4) Fuel Tank Sump Quick Drain Valves – DRAIN
Drain at least a cupful of fuel (using sampler cup) from each sump location to check for water, sediment and proper fuel grade (Diesel or Jet-A1) before each flight and after each refueling. If water is observed, take further samples until clear and then gently rock wings and lower tail to the ground to move any additional contaminants to the sampling points. Take repeated samples from all fuel drain points until all contamination has been removed. If contaminants are still present, refer to WARNING below and do not fly airplane.

▲ **WARNING:** If, after repeated sampling, evidence of contamination still exists, the airplane should not be flown. Tanks should be drained and system purged by qualified maintenance personnel. All evidence of contamination must be removed before further flight.

◆ Note: Collect all sampled fuel in a safe container. Dispose of the sampled fuel so that it does not cause a nuisance, hazard or damage to the environment.

- (5) Fuel Quantity – CHECK VISUALLY (for desired level)
(6) Fuel Filler Cap – SECURE and VENT CLEAR

(5) NOSE

- (1) Reservoir-tank Quick Drain Valve – DRAIN at least a cupful of fuel (using sampler cup) from valve to check for water, sediment and proper fuel grade (Diesel or JET-A1) before each flight and after each refueling. If water is observed, take further samples until clear and then gently rock wings and lower tail to the ground to move any additional contaminants to the sampling point. Take repeated samples until all contamination has been removed.

◆ Note: The reservoir tank drain is located in the fuselage on the co-pilot side of the aircraft.

- (2) Before first flight of the day and after each refueling – DRAIN the Fuel Strainer Quick Drain Valve with the sampler cup to remove water and sediment from the screen. Ensure that the screen drain is properly closed again. If water is discovered, there might be even more water in the fuel system. Therefore, take further samples from Fuel Strainer and the Tank Sumps.

▲ **WARNING:** If, after repeated sampling, evidence of contamination still exists, the airplane should not be flown. Tanks should be drained and system purged by qualified maintenance personnel. All evidence of contamination must be removed before further flight.

◆ Note: The fuel strainer drain is located on the left-hand side of the firewall (flight direction).

◆ Note: Collect all sampled fuel in a safe container. Dispose of the sampled fuel so that it does not cause a nuisance, hazard or damage to the environment.

- (3) Engine Oil Dipstick/Filler Cap:
 - a) Oil level – CHECK
 - b) Dipstick/filler cap – SECUREDo not operate below the minimum dipstick indication.
- (4) Engine Cooling Air Inlets – CHECK (clear of obstructions)
- (5) Propeller and Spinner – CHECK (for nicks and security)
- (6) Gearbox Oil Level – CHECK the oil has to cover at least half of the inspection glass
- (7) Nose Wheel Strut and Tire – CHECK for proper inflation of strut and general condition (weather checks, tread depth and wear, etc.) of tire
- (8) Left Static Source Opening – CHECK for blockage
- (9) Fuel cooler baffle – CHECK
 - REMOVE, if OAT on ground in higher than 20°C (68°F)
 - INSTALL, if OAT on ground in lower than 20°C (68°F)

(6) LEFT WING

- (1) Fuel Quantity – CHECK VISUALLY for desired level not above marking in fuel filler
- (2) Fuel Filler Cap – SECURE
- (3) Fuel Tank Sump Quick Drain Valves (5) – DRAIN
Drain at least a cupful of fuel (using sampler cup) from each sump location to check for water, sediment and the right type of fuel (Diesel or JET-A1) before each flight and after each refueling. If water is observed, take further samples until clear and then gently rock wings and lower tail to the ground to move any additional contaminants to the sampling points. Take repeated samples from all fuel drain points until all contamination has been removed. If contaminants are still present, refer to previous WARNING (see right wing) and do not fly airplane.

▲ **WARNING:** If, after repeated sampling, evidence of contamination still exists, the airplane should not be flown. Tanks should be drained and system purged by qualified maintenance personnel. All evidence of contamination must be removed before further flight.

◆ **Note:** Collect all sampled fuel in a safe container. Dispose of the sampled fuel so that it does not cause a nuisance, hazard or damage to the environment.

- (4) Main Wheel Tire – CHECK for proper inflation and general condition (weather checks, tread depth and wear, etc.)

(7) LEFT WING Leading Edge

- (1) Pitot Tube Cover (if mounted) – REMOVE and CHECK for pitot blockage
(2) Fuel Tank Vent Opening – CHECK for blockage
(3) Stall Warning Opening – CHECK for blockage

◆ **Note:** To check the system, place a clean handkerchief over the vent opening and apply suction; a sound from the warning horn will confirm system operation.

- (4) Wing Tie-Down – DISCONNECT
(5) Landing/Taxi Light(s) – CHECK for condition and cleanliness of cover

(8) LEFT WING Trailing Edge

- (1) Aileron – CHECK (freedom of movement and security)
(2) Flap – Check (security and conditions)

BEFORE STARTING ENGINE

- (1) Preflight Inspection – COMPLETE
- (2) Passenger Briefing – COMPLETE
- (3) Seats and Seat Belts – ADJUST and LOCK (verify inertia reel locking)
- (4) Brakes – TEST and SET
- (5) Circuit Breakers – CHECK IN
- (6) Electrical Equipment – OFF
- (7) AVIONICS Switch (BUS 1 and BUS 2) – OFF

■ **CAUTION:** The Avionics Switch (BUS 1 and BUS 2) must be off during engine start to prevent possible damage to avionics.

■ **CAUTION:** The electronic engine control needs an electrical power source for its operation. For normal operation Battery, Alternator and Main Bus have to be switched on. Separate switching is only allowed for tests and in the event of emergencies.

- (8) Fuel Selector Valve – SET to BOTH position.
- (9) Fuel Shut-off Valve – OPEN (Push Full In)
- (10) Alternate Air Door – CLOSED
- (11) Thrust Lever – CHECK for freedom of movement
- (12) Engine Master – OFF

PROCEDURES UP TO 5500ft AIRFIELD ELEVATION

STARTING ENGINE

▲ **WARNING:** Do not use ground power unit for engine starts. It is not allowed to start up the engine using external power. If starting the engine is not possible using battery power, the condition of the battery must be verified before flight.

- (1) STBY BATT Switch:
 - a) TEST – (hold for 10 seconds, verify that green TEST lamp does not go off)
 - b) ARM – (verify that PFD comes on)
- (2) Fuel Quantity – CHECK
- (3) Thrust Lever – IDLE
- (4) MASTER Switch (BAT) – ON
- (5) Engine Master Switch – ON, wait until the Glow Control light extinguishes
- (6) Engine Indicating System – CHECK PARAMETERS (verify no red X's through engine page indicators)
- (7) BUS E Volts – CHECK (verify 24 VOLTS minimum shown)
- (8) M BUS Volts – CHECK (verify 24 VOLTS or less shown)
- (9) BATT S Amps – CHECK (verify discharge shown (negative))
- (10) STBY BATT Annunciator – CHECK (verify annunciator is shown)
- (11) Propeller Area – CLEAR (verify that all people and equipment are at a safe distance from the propeller)
- (12) BEACON Light Switch – ON
- (13) FUEL PUMP Switch – ON
- (14) Starter – ON (keep starter engaged until min. 500 rpm, release when engine starts, leave Thrust Lever in idle)

-
- **CAUTION:** Do not overheat the starter motor. Do not operate the starter motor for more than 10 seconds. After operating the starter motor, let it cool off for 20 seconds. After 6 attempts to start the engine, let the starter cool off for half an hour.
-

(15) Oil Pressure – CHECK (verify that oil pressure in GREEN BAND range within 3 seconds)

- **CAUTION:** If after 3 seconds the minimum oil pressure of 1 bar is not indicated: shut down the engine immediately!
-

(16) AMPS (M BATT and BATT S) – CHECK (verify charge shown (positive))

(17) LOW VOLTS Annunciator – CHECK (verify annunciator is not shown)

(18) Fuel Pump – OFF

(19) FADEC Backup Battery Test

- a) Alternator – OFF, engine must operate normally
 - b) MASTER Switch (BAT) – OFF, for min. 10 seconds; engine must operate normally (E-Bus-Volts > 24.5V), FADEC B Warning Annunciator - ON
 - c) MASTER Switch (BAT) – ON
 - d) Alternator – ON
 - e) FADEC A and FADEC B Warning Annunciator - OFF
-

- ▲ **WARNING:** It must be ensured that both battery and alternator are ON!
If the guarded alternator switch is installed, the switch guard must be closed.
-

(20) Navigation Lights – ON (as required).

(21) Avionics Switch (BUS 1 and BUS 2) – ON

(22) BUS E Volts – CHECK (verify 28 VOLTS minimum shown)

(23) M BUS Volts – CHECK (verify 28 VOLTS minimum shown)

(24) M-BAT AMP – Check positive charge, LOW VOLT Annunciator must be OFF

(25) Flaps – RETRACT

WARM UP

- (1) Let the engine warm up about 2 minutes at 890 RPM.
- (2) Increase RPM to 1,400 until Oil Temperature 50°C (122°F), Coolant Temperature 60°C (140°F).

BEFORE TAKE-OFF

- (1) Parking Brake – SET
- (2) Passenger Seat Backs – MOST UPRIGHT POSITION
- (3) Seats and Seat Belts – CHECK SECURE
- (4) Cabin Doors – CLOSED and LOCKED
- (5) Flight Controls – FREE and CORRECT
- (6) Flight Instruments (PFD) – CHECK and SET (no red X's)
- (7) Altimeters:
 - a) PFD (BARO) – SET
 - b) Standby Altimeter – SET
- (8) ALT SEL – SET
- (9) Standby Flight Instruments – CHECK
- (10) Fuel quantity – CHECK (verify level is correct)
- (11) Fuel temperature – CHECK. The fuel temperature limitations must be observed.

◆ Note: Flight is not recommended when both fuel quantity indicators are in the yellow band range.

- (12) Fuel Selector Valve – SET BOTH
- (13) Autopilot – ENGAGE (if installed) (push AP button on either PFD or MFD bezel)
- (14) Flight Controls – CHECK (verify autopilot can be overpowered in both pitch and roll axes)
- (15) A/P TRIM DISC Button – PRESS (if installed) (verify autopilot disengages and aural alert is heard)
- (16) Flight Director – OFF (if installed) (push FD button on either PFD or MFD bezel)
- (17) Elevator Trim – SET for Takeoff

-
-
- (18) FADEC and propeller adjustment function check:
- a) Thrust Lever – IDLE (no FADEC warning)
 - b) FADEC Test Button – PRESS and HOLD button for entire test
 - c) FADEC-TEST and both FADEC Warning Annunciators – ON, RPM increases.
 - d) The FADEC automatically switches to B-component (only FADEC-B Warning Annunciator is ON)
 - e) The propeller control is excited, RPM decreases
 - f) The FADEC automatically switches to channel A (only FADEC-A Warning Annunciator is ON), RPM increases
 - g) The propeller control is excited, RPM decreases
 - h) FADEC-TEST and both FADEC Warning Annunciators – OFF, idle RPM is reached, the test is completed.
 - i) FADEC Test Button – RELEASE

▲ **WARNING:** If there are prolonged engine misfires or the engine shuts down during the test, take off may not be attempted.

▲ **WARNING:** The whole FADEC-Test procedure has to be performed without any failure. In case the engine shuts down or a FADEC warning is indicated, take off is prohibited. This applies even if the engine seems to run without failure after the test.

◆ **Note:** If the test button is released before the self test is over, the FADEC immediately switches over to normal operation.

◆ **Note:** While switching from one FADEC to another, it is normal to hear and feel a momentary surge in the engine.

(19) Force B Switch – switch to FADEC B (FADEC FORCE B Annunciator) – Engine check (running without a change)

(20) Force B Switch – switch back to Automatic

(21) Thrust Lever – FULL FORWARD

- a) load display min. 94%, RPM 2240 - 2300
- b) VAC-Indicator – CHECK
- c) Engine Indicators – CHECK
- d) Ammeters and Voltmeters – CHECK
- e) Annunciators – CHECK (verify no annunciators are shown)

(22) Thrust Lever – IDLE

(23) Throttle Control Friction Lock – ADJUST

(24) COM Frequency(s) – SET

(25) NAV Frequency(s) – SET

(26) FMS/GPS Flight Plan – AS DESIRED

◆ Note: GPS availability and status can be checked on AUX-GPS STATUS page.

(27) XPDR – SET

(28) CDI Softkey – SELCTNAV SOURCE

▲ **WARNING:** The G1000 HSI shows a course deviation indicator for the selected GPS, NAV 1 or NAV 2 navigation source. The G1000 HSI does not provide a warning flag when a valid navigation signal is not being supplied to the indicator. When a valid navigation signal is not being supplied, the course deviation bar (D-bar) part of the indicator is not shown on the HSI compass card. The missing D-bar is considered to be the warning flag.

▲ WARNING: When the autopilot is engaged in NAV, APR or BC operating modes, if the HSI navigation source is changed manually, using the CDI softkey, the change will interrupt the navigation signal to the autopilot and will cause the autopilot to revert to ROL mode operation. No aural alert will be provided. In ROL mode, the autopilot will only keep the wings level and will not correct the airplane heading or course. Set the HDG bug to the correct heading and select the correct navigation source on the HSI, using the CDI softkey, before engaging the autopilot in any other operating mode.

- (29) CABIN PWR 12V Switch – OFF
- (30) Air Conditioning (if installed) – OFF
- (31) Wing Flaps – SET for Take-off (0° or 10°)
- (32) Cabin Windows – CLOSED and LOCKED
- (33) Electric Fuel Pump – ON
- (34) Strobe Light Switch – ON
- (35) Autopilot (if installed) – OFF
- (36) Thrust Lever Friction Control – ADJUST
- (37) Brakes – RELEASE

PROCEDURES OVER 5500ft AIRFIELD ELEVATION

- ◆ **Note:** Due to the increase of the idle speed with increasing pressure altitudes, the FADEC test is only possible to a limited extent from an airfield elevation of approximately 5500ft.
- Over 5500ft, the FADEC test is only possible if the load selector lever remains in the idle position after engine start until the FADEC test is starting.
- If the load selector lever is moved from the idle position, a FADEC test is no longer possible at pressure altitudes above 5500ft. For this purpose, the engine has to be stopped and re-started to perform the FADEC test.

STARTING ENGINE

-
- ▲ **WARNING:** Do not use ground power unit for engine starts. It is not allowed to start up the engine using external power. If starting the engine is not possible using battery power, the condition of the battery must be verified before flight.
-

- (1) STBY BATT Switch:
 - a) TEST – (hold for 10 seconds, verify that green TEST lamp does not go off)
 - b) ARM – (verify that PFD comes on)
- (2) Fuel Quantity – CHECK
- (3) Thrust Lever – IDLE
- (4) MASTER Switch (BAT) – ON
- (5) Engine Master Switch – ON, wait until the Glow Control light extinguishes
- (6) Engine Indicating System – CHECK PARAMETERS (verify no red X's through engine page indicators)
- (7) BUS E Volts – CHECK (verify 24 VOLTS minimum shown)

-
- (8) M BUS Volts – CHECK (verify 24 VOLTS or less shown)
 - (9) BATT S Amps – CHECK (verify discharge shown (negative))
 - (10) STBY BATT Annunciator – CHECK (verify annunciator is shown)
 - (11) Propeller Area – CLEAR (verify that all people and equipment are at a safe distance from the propeller)
 - (12) BEACON Light Switch – ON
 - (13) FUEL PUMP Switch – ON
 - (14) Starter – ON (keep starter engaged until min. 500 rpm, release when engine starts, leave Thrust Lever in idle)

■ **CAUTION:** Do not overheat the starter motor. Do not operate the starter motor for more than 10 seconds. After operating the starter motor, let it cool off for 20 seconds. After 6 attempts to start the engine, let the starter cool off for half an hour.

-
- (15) Oil Pressure – CHECK (verify that oil pressure in GREEN BAND range within 3 seconds)

■ **CAUTION:** If after 3 seconds the minimum oil pressure of 1 bar is not indicated: shut down the engine immediately!

-
- (16) AMPS (M BATT and BATT S) – CHECK (verify charge shown (positive))
 - (17) LOW VOLTS Annunciator – CHECK (verify annunciator is not shown)
 - (18) Fuel Pump – OFF
 - (19) FADEC Backup Battery Test
 - a) Alternator – OFF, engine must operate normally
 - b) MASTER Switch (BAT) – OFF, for min. 10 seconds; engine must operate normally (E-Bus-Volts > 24.5V), FADEC B Warning Annunciator - ON
 - c) MASTER Switch (BAT) – ON
 - d) Alternator – ON
 - e) FADEC A and FADEC B Warning Annunciator - OFF

▲ **WARNING:** It must be ensured that both battery and alternator are ON!
If the guarded alternator switch is installed, the switch guard must be closed.

- (20) Navigation Lights – ON (as required).
- (21) Avionics Switch (BUS 1 and BUS 2) – ON
- (22) BUS E Volts – CHECK (verify 28 VOLTS minimum shown)
- (23) M BUS Volts – CHECK (verify 28 VOLTS minimum shown)
- (24) M-BAT Amp – Check positive charge, LOW VOLT Annunciator must be OFF
- (25) Flaps – RETRACT

WARM UP AND FADEC-TEST

- (1) Let the engine warm up about 2 minutes at 890 RPM.
- (2) Increase RPM to 1,400 until Oil Temperature 50°C (122°F), Coolant Temperature 60°C (140°F).
- (3) Engine Master – OFF
- (4) Propeller Area – CLEAR (verify that all people and equipment are at a safe distance from the propeller)
- (5) Engine Master Switch – ON, wait until the Glow Control light extinguishes
- (6) Starter – ON (keep starter engaged until min. 500 rpm, release when engine starts, leave Thrust Lever in idle)
- (7) FADEC and propeller adjustment function check:
 - a) Thrust Lever – IDLE (no FADEC warning)
 - b) FADEC Test Button – PRESS and HOLD button for entire test
 - c) FADEC-TEST and both FADEC Warning Annunciators – ON, RPM increases.
 - d) The FADEC automatically switches to B-component (only FADEC-B Warning Annunciator is ON)
 - e) The propeller control is excited, RPM decreases
 - f) The FADEC automatically switches to channel A (only FADEC-A Warning Annunciator is ON), RPM increases
 - g) The propeller control is excited, RPM decreases

-
-
- h) FADEC-TEST and both FADEC Warning Annunciators – OFF, idle RPM is reached, the test is completed.
 - i) FADEC Test Button – RELEASE

▲ **WARNING:** If there are prolonged engine misfires or the engine shuts down during the test, take off may not be attempted.

▲ **WARNING:** The whole FADEC-Test procedure has to be performed without any failure. In case the engine shuts down or a FADEC warning is indicated, take off is prohibited. This applies even if the engine seems to run without failure after the test.

◆ **Note:** If the test button is released before the self test is over, the FADEC immediately switches over to normal operation.

◆ **Note:** While switching from one FADEC to another, it is normal to hear and feel a momentary surge in the engine.

- (8) Force B Switch – switch to FADEC B (FADEC FORCE B Annunciator) – Engine check (running without a change)
- (9) Engine – check running without a change
- (10) Force B Switch – switch back to Automatic
- (11) Avionics Switch (BUS 1 and BUS 2) – ON
- (12) Electric Fuel Pump – OFF

BEFORE TAKE-OFF

- (1) Parking Brake – SET
- (2) Passenger Seat Backs – MOST UPRIGHT POSITION
- (3) Seats and Seat Belts – CHECK SECURE
- (4) Cabin Doors – CLOSED and LOCKED
- (5) Flight Controls – FREE and CORRECT
- (6) Flight Instruments (PFD) – CHECK and SET (no red X's)

-
-
- (7) Altimeters:
 - a) PFD (BARO) – SET
 - b) Standby Altimeter – SET
 - (8) ALT SEL – SET
 - (9) Standby Flight Instruments – CHECK
 - (10) Fuel quantity – CHECK (verify level is correct)
 - (11) Fuel temperature – CHECK. The fuel temperature limitations must be observed.

◆ Note: Flight is not recommended when both fuel quantity indicators are in the yellow band range.

- (12) Fuel Selector Valve – SET BOTH
- (13) Autopilot – ENGAGE (if installed) (push AP button on either PFD or MFD bezel)
- (14) Flight Controls – CHECK (verify autopilot can be overpowered in both pitch and roll axes)
- (15) A/P TRIM DISC Button – PRESS (if installed) (verify autopilot disengages and aural alert is heard)
- (16) Flight Director – OFF (if installed) (push FD button on either PFD or MFD bezel)
- (17) Elevator Trim – SET for Takeoff
- (18) Thrust Lever – FULL FORWARD
 - a) load display min. 94%, RPM 2240 - 2300
 - b) VAC-Indicator – CHECK
 - c) Engine Indicators – CHECK
 - d) Ammeters and Voltmeters – CHECK
 - e) Annunciators – CHECK (verify no annunciators are shown)
- (19) Thrust Lever – IDLE
- (20) Throttle Control Friction Lock – ADJUST
- (21) COM Frequency(s) – SET
- (22) NAV Frequency(s) – SET

(23) FMS/GPS Flight Plan – AS DESIRED

-
- ◆ Note: GPS availability and status can be checked on AUX-GPS STATUS page.
-

(24) XPDR – SET

(25) CDI Softkey – SELCTNAV SOURCE

-
- ▲ **WARNING:** The G1000 HSI shows a course deviation indicator for the selected GPS, NAV 1 or NAV 2 navigation source. The G1000 HSI does not provide a warning flag when a valid navigation signal is not being supplied to the indicator. When a valid navigation signal is not being supplied, the course deviation bar (D-bar) part of the indicator is not shown on the HSI compass card. The missing D-bar is considered to be the warning flag.
-

-
- ▲ **WARNING:** When the autopilot is engaged in NAV, APR or BC operating modes, if the HSI navigation source is changed manually, using the CDI softkey, the change will interrupt the navigation signal to the autopilot and will cause the autopilot to revert to ROL mode operation. No aural alert will be provided. In ROL mode, the autopilot will only keep the wings level and will not correct the airplane heading or course. Set the HDG bug to the correct heading and select the correct navigation source on the HSI, using the CDI softkey, before engaging the autopilot in any other operating mode.
-

(26) CABIN PWR 12V Switch – OFF

(27) Air Conditioning (if installed) – OFF

(28) Wing Flaps – SET for Take-off (0° or 10°)

-
-
- (29) Cabin Windows – CLOSED and LOCKED
 - (30) Electric Fuel Pump – ON
 - (31) Strobe Light Switch – ON
 - (32) Autopilot (if installed) – OFF
 - (33) Thrust Lever Friction Control – ADJUST
 - (34) Brakes – RELEASE

TAKE-OFF

NORMAL TAKEOFF

- (1) Wing Flaps – 0° or 10°
- (2) Thrust Lever – FULL FORWARD
- (3) Elevator Control – LIFT NOSE WHEEL at 55 KIAS
- (4) Climb Speed – 70 to 80 KIAS

SHORT FIELD TAKEOFF

- (1) Wing Flaps – 10°
- (2) Brakes – APPLY
- (3) Thrust Lever – FULL FORWARD
- (4) Brakes – RELEASE
- (5) Elevator Control – SLIGHTLY TAIL LOW
- (6) Elevator Control – LIFT NOSE WHEEL at 51 KIAS
- (7) Climb Speed – 56 KIAS (until all obstacles are cleared)

AFTER TAKEOFF

- (1) Altitude about 300 ft, Airspeed more than 65 KIAS – Wing Flaps – RETRACT
- (2) Electric Fuel Pump – OFF

CLIMB**(1) Airspeed – 70 to 85 KIAS**

◆ Note: If a maximum performance climb is necessary, use speeds shown in the "Maximum Rate Of Climb" chart in Section 5. In case that Oil Temperature and/or Coolant Temperature are approaching the upper limit, continue at a lower climb angle for better cooling if possible.

◆ Note: It is recommended to set the fuel selector valve to the BOTH position. The fuel temperatures have to be monitored.

(2) Thrust Lever – FULL FORWARD

CRUISE

- (1) Power – maximum load 100% (maximum continuous power), 75% or less is recommended.
For economic cruise set load 70% or less.
- (2) Elevator trim – ADJUST
- (3) Compliance with Limits for Oil Pressure, Oil Temperature, Coolant Temperature and Gearbox Temperature – MONITOR closely
- (4) Fuel Quantity and Temperature – MONITOR.

Whenever possible, the airplane should be flown with the fuel selector in the BOTH position to empty and heat both fuel tanks evenly. However, operation in the LEFT or RIGHT position may be desirable to correct a fuel quantity imbalance or during periods of intentional uncoordinated flight manoeuvres. During prolonged operation with the fuel selector in either the LEFT or RIGHT position the fuel balance and temperatures should be closely monitored.

■ CAUTION: Do not use any fuel tank below the minimum permissible fuel temperature!

■ CAUTION: In turbulent air it is strongly recommended to use the BOTH position.

■ CAUTION: With $\frac{1}{4}$ tank or less prolonged or uncoordinated flight is prohibited when operating on either the left or right tank.

- (5) FADEC and Alternator Warning – MONITOR

DESCENT

- (1) Power – AS DESIRED
- (2) Altimeters:
 - a) PFD (BARO) – SET
 - b) Standby Altimeter – SET
- (3) ALT SEL – SET
- (4) CDI Softkey – SELECT NAV SOURCE
- (5) FMS/GPS – REVIEW and BRIEF (OBS/SUSP softkey operation for holding pattern procedure (IFR))

▲ **WARNING:** The G1000 HSI shows a course deviation indicator for the selected GPS, NAV 1 or NAV 2 navigation source. The G1000 HSI does not provide a warning flag when a valid navigation signal is not being supplied to the indicator. When a valid navigation signal is not being supplied, the course deviation bar (D-bar) part of the indicator is not shown on the HSI compass card. The missing D-bar is considered to be the warning flag.

▲ **WARNING:** When the autopilot is engaged in NAV, APR or BC operating modes, if the HSI navigation source is changed manually, using the CDI softkey, the change will interrupt the navigation signal to the autopilot and will cause the autopilot to revert to ROL mode operation. No aural alert will be provided. In ROL mode, the autopilot will only keep the wings level and will not correct the airplane heading or course. Set the HDG bug to the correct heading and select the correct navigation source on the HSI, using the CDI softkey, before engaging the autopilot in any other operating mode.

- (6) FUEL SELECTOR Valve – BOTH
- (7) Wing Flaps – AS DESIRED (UP – 10° below 110 KIAS)
(10° – FULL below 85 KIAS)

BEFORE LANDING

- (1) Pilot and Passenger Seat Backs – MOST UPRIGHT POSITION
- (2) Seats and Seat Belts – SECURED and LOCKED
- (3) Fuel Selector Valve – SELECT BOTH position
- (4) Air Conditioning (if installed) – OFF
- (5) Electric Fuel Pump – ON
- (6) Landing / Taxi Lights – ON
- (7) Autopilot (if installed) – OFF
- (8) CABIN PWR 12V Switch – OFF

LANDING

NORMAL LANDING

- (1) Airspeed – 65 KIAS (wing flaps UP)
- (2) Wing Flaps – AS DESIRED (0°-10° below 110 KIAS;
10° – Full 40° below 85 KIAS)
- (3) Airspeed in Final Approach – 60 to 70 KIAS (Flaps DOWN)
- (4) Touchdown – MAIN WHEELS FIRST
- (5) Landing Roll – LOWER NOSE WHEEL GENTLY
- (6) Brakes – MINIMUM REQUIRED

SHORT FIELD LANDING

- (1) Airspeed – 69 to 80 KIAS (Flaps UP)
- (2) Wing Flaps – FULL DOWN
- (3) Airspeed in the Final Approach – 61 KIAS (until flare)
- (4) Power – REDUCE to idle after clearing obstacles.
- (5) Touchdown – MAIN WHEELS FIRST
- (6) Brakes – APPLY HEAVILY
- (7) Wing Flaps – UP

BALKED LANDING

- (1) Thrust Lever – FULL FORWARD
- (2) Wing Flaps – RETRACT TO 20° (immediately after Thrust Lever FULL FORWARD)

-
- (3) Climb Speed – 58 KIAS
 - (4) Wing Flaps – 10° (until all obstacles are cleared)
 - (5) Wing Flaps – RETRACT after reaching a safe altitude and 65 KIAS

AFTER LANDING

- (1) Wing Flaps – UP
- (2) Electric Fuel Pump – OFF
- (3) STROBE Light Switch – OFF

SECURING AIRPLANE

- (1) Parking Brake – SET
- (2) Thrust Lever – IDLE
- (3) Electrical Equipment – OFF
- (4) Avionics Switch (BUS1 and BUS2) – OFF
- (5) Engine Master – OFF
- (6) MASTER Switch (BAT) – OFF
- (7) Control Lock – INSTALL
- (8) STBY BATT Switch – OFF
- (9) Fuel Selector Valve – LEFT or RIGHT (to prevent crossfeeding between tanks)

AMPLIFIED PROCEDURES

STARTING ENGINE

The TAE 125-02-114 is a direct Diesel injection engine with common-rail technology and a turbocharger. It is controlled automatically by the FADEC, which makes a proper performance of the FADEC test important for safe flight operation. All information relating to the engine are compiled in the PFD or MFD (Engine Page).

Potentiometers within the Thrust Lever transmit the load value selected by the pilot to the FADEC.

If the engine master is switched to ON, the preheating relay is actuated by the FADEC and the glow plugs are supplied with power. The glow duration depends on the engine temperature. If the engine master is switched to OFF, the injection valves are not supplied with power and remain closed.

The switch/push button "Starter" controls the Starter.

EXTERNAL POWER

External power may be used to charge the battery or for maintenance purposes. Refer to original instructions.

To charge the battery with external power the battery switch must be ON.

When using an External Power Source, the Battery Switch must be in the OFF position before connecting the External Power Source to the airplane receptacle.

It is not allowed to start up the engine using external power. If starting the engine is not possible using battery power, the condition of the battery must be verified before flight.

TAXIING

When taxiing, it is important that speed and use of brakes be held to a minimum and that all controls be utilized to maintain directional control and balance.

The Alternate Air Door should be always for ground operation to ensure that no unfiltered air is sucked in.

Taxiing over loose gravel or cinders should be done at low engine speed to avoid abrasion and stone damage to the propeller tips.

BEFORE TAKE-OFF

WARM UP

To warm up the engine, operate the engine for about 2 minutes at 890 RPM.

Let the engine run at propeller RPM of 1,400 until it reaches an engine oil temperature of 50°C (green range) and a coolant temperature of 60°C (green range to ensure normal operation).

MAGNETO CHECK

N/A

ALTERNATOR CHECK

Prior to flights where verification of proper alternator and alternator control unit operation is essential (such as night and instrument flights), a positive verification can be made by loading the electrical system momentarily (3 to 5 seconds) with the landing light or by operating the wing flaps during the engine runup (20% load). The ammeter will remain within a needle width of zero if the alternator and alternator control unit are operating properly.

BATTERY CHECK

If there is doubt regarding the battery conditions or functionality the battery has to be checked after warm-up as follows:

Switch off the alternator while the engine is running (battery remains "ON")

Perform a 10 sec. engine run. The voltmeter must remain in the green range. If not, the battery has to be charged or, if necessary, exchanged.

After this test the alternator has to be switched on again.

TAKE-OFF

POWER CHECK

It is important to check full load engine operation early in the takeoff roll. Any signs of rough engine operation or sluggish engine acceleration is good cause for discontinuing the take-off. If this occurs, you are justified in making a thorough full load static runup before another take-off is attempted.

After full load is applied, adjust the Thrust Lever Friction Control to prevent the Thrust Lever from creeping back from a maximum power position. Similar friction lock adjustments should be made as required in other flight conditions to maintain a fixed Thrust Lever setting.

WING FLAP SETTINGS

Flap deflections greater than 10° are not approved for normal and short field takeoffs. Using 10° wing flaps reduces the ground roll and total distance over a 15 m obstacle by approximately 10%.

CLIMB

Normal climbs are performed with flaps up and full load and at speeds 5 to 10 knots higher than best rate-of-climb speeds for the best combination of engine cooling, climb speed and visibility. The speed for best climb is about 70 KIAS.

◆ Note: Climbs at low speeds should be of short duration to improve engine cooling.

CRUISE

As guidance for calculation of the optimum altitude and power setting for a given flight use the tables in chapter 5.

LANDING

NORMAL LANDING

N/A

BALKED LANDING

In a balked landing (go around) climb, reduce the flap setting to 20° immediately after full power is applied. If obstacles must be cleared during the go-around climb, reduce wing flap setting to 10° and maintain a safe airspeed until the obstacles are cleared. After clearing any obstacles, the flaps may be retracted as the airplane accelerates to the normal flaps up climb speed.

CARBURETOR ICING

N/A

FLIGHT IN HEAVY RAIN

N/A

COLD WEATHER OPERATION

Special attention should be paid to operation of the aircraft and the fuel system in winter or before any flight at low temperatures. Correct preflight draining of the fuel system is particularly important and will prevent the accumulation of water.

The following limitations for cold weather operation are established due to temperature. "Operating limits".

(Refer Section 2 "Limitations" also)

Fuel	Minimum permissible fuel temperature in the fuel tank before Take-off	Minimum permissible fuel temperature in the fuel tank during the flight
JET A-1, JET-A, Fuel No.3 JP-8 JP8+100 TS-1	-30°C	-35°C
Diesel Sasol GTL Diesel	greater than 0°C	-5°C

Figure 4-1a Minimum fuel temperature limits in the fuel tank

▲ **WARNING:** The fuel temperature of the fuel tank not in use should be observed if it is intended for later use.

▲ **WARNING:** The following applies to Diesel and Jet fuel mixtures in the tank:
As soon as the proportion of Diesel in the tank is more than 10% Diesel, the fuel temperature limits have to be observed for Diesel operation. If there is uncertainty about the type of fuel in the tank, the assumption should be made that it is Diesel.

◆ Note: It is advisable to refuel before each flight and to enter the type of fuel filled and the additives used in the log-book of the airplane.

If snow or slush covers the take-off surface, allowance must be made for take-off distances which will be increasingly extended as snow or slush depth increases. The depth and consistency of this cover can, in fact, prevent take-off in many instances.

Cold weather starting procedures are the same as the normal starting procedures. Use caution to prevent inadvertent forward movement of the airplane during starting when parked on snow or ice.

HOT WEATHER OPERATION

Engine temperatures may rise into the amber range and activate the "Caution" light when operating in hot weather or longer climbouts at low speed. This indication gives the pilot the opportunity to keep the engine from possibly overheating by doing the following:

- i) decrease rate of climb
- ii) increase airspeed
- iii) reduce power, if the engine temperatures approach the red range

Should the seldom case occur that the fuel temperature is rising into the amber or red range, switch to the other tank or to the BOTH position.

This page intentionally left blank



SECTION 5 PERFORMANCE

SAMPLE PROBLEM

The following sample flight problem utilizes information from the various tables and diagrams of this section to determine the predicted performance data for a typical flight.

Assume the following information has already been determined:

AIRPLANE CONFIGURATION

Takeoff Weight..... 1111 kg (2450 lb)
Usable Fuel 168.8 l (44.6 US gal)

TAKEOFF CONDITIONS

Field Pressure Altitude..... 1500ft
Temperature 28°C (ISA +16°C)Wind
Component along Runway..... 12 Knot Headwind
Field Length 1070 m (3500 ft)

CRUISE CONDITIONS

Total Distance 852 km (460 NM)
Pressure Altitude..... 5500 ft
Temperature 20°C (ISA + 16°C)
Expected Wind Enroute 10 Knot Headwind

LANDING CONDITIONS

Field Pressure Altitude..... 2000 ft
Temperature 25°C
Field Length 915 m (3000 ft)

GROUND ROLL AND TAKE-OFF

The ground roll and take-off distance chart, Figure 5-1e (Takeoff Distance), should be consulted, keeping in mind that distances shown are based on the short field technique. Conservative distances can be established by reading the chart at the next higher value of weight, temperature and altitude. For example, in this particular sample problem, the takeoff distance information presented for a weight of 1111 kg, pressure altitude of 2000 ft and a temperature of 30°C should be used and results in the following:

Ground Roll.....332 m (1090 ft)
Total Distance to clear a 15 m obstacle.....569m (1867 ft)

These distances are well within the available takeoff field length. However, a correction for the effect of wind may be made based on Note 2 of the takeoff chart. The correction for a 12 Knot Headwind is:

$$\frac{12 \text{ Kt}}{9 \text{ Kt}} \times 10 \% = 13 \% \text{ (Decrease)}$$

This results in the following distances, corrected for wind:

Ground Roll, zero wind332 m(1090 ft)
Decrease at 12 Knot Headwind (332m x 13%)= - 43 m (142 ft)
Corrected Ground Roll 289 m (948 ft)

Total Distance to clear a 15 m obstacle,
zero wind..... 569 m (1867 ft)
Decrease at 12 Knot Headwind (569m x 13%)= . - 74 m (243 ft)
Corrected Total Distance to clear a 495m (1624 ft)
15 m obstacle

CRUISE

The cruising altitude should be selected based on a consideration of trip length, winds aloft and the airplanes performance. A typical cruising altitude and the expected wind enroute have been given for this sample problem. However, the power setting selection for cruise must be determined based on several considerations. These include the cruise performance characteristics presented in Figures 5-4. Considerable fuel savings and longer range result when lower power settings are used.

Figure 5-4c shows a range of 758 NM at zero wind, a power setting of 70% and altitude of 6,000 ft.

With an expected headwind of 10 Knot at 5,500 ft altitude the range has to be corrected as follows:

Range at zero wind (standard tanks)	758 NM
Reduction due to Headwind..... (6.4 h x 10 Knots) =	<u>64 NM</u>
Corrected Range.....	694 NM

This shows that the flight can be performed at a power setting of approximately 70% with full tanks without an intermediate fuel stop.

Figure 5-4c is based on ISA conditions. For a temperature of 16°C above ISA temperature, according to Note 3, true airspeed and maximum range are increased by 1.6 %.

The following values most nearly correspond to the planned altitude and expected temperature conditions. Engine Power setting chosen is 70%.

The resultants are:

Engine Power:.....	70%
True Airspeed:	115 kt
Fuel Consumption in cruise:	22.1 l/h (5.8 US gal/h)

FUEL REQUIRED

The total fuel requirement for the flight may be estimated using the performance information in Figures 5-2 and 5-4. For this sample problem, Figure 5-2c shows that a climb from 1000 ft to 6,000 ft requires 3.8 l (1.0 US gal) of fuel. The corresponding distance during the climb is 8.7 NM. These values are for a standard temperature and are sufficiently accurate for most flight planning purposes.

However, a further correction for the effect of temperature may be made as noted in Note 2 of the climb chart in Figure 5-2c. An effect of 10°C above the standard temperature is to increase time and distance by 10% due to the lower rate of climb.

In this case, assuming a temperature 16°C above standard, the correction would be:

$$\frac{16\text{ }^{\circ}\text{C}}{10\text{ }^{\circ}\text{C}} \times 10\% = 16\% \text{ (Increase)}$$

With this factor included, the fuel estimate would be calculated as follows:

Fuel to climb, standard temperature:

3.8 l (1.0 US gal)

Increase due to non-standard temperature:

3.8 l (1.0 US gal) x 16% = 0.6 l (0.2 US gal)

Corrected fuel to climb:

4.4 l (1.2 US gal)

Using a similar procedure for the distance to climb results in 10.1 NM.

The resultant cruise distance is:

Total Distance 460.0 NM
Climbout Distance - 10.1 NM
Cruise Distance..... 449.9 NM

With an expected 10 Kt headwind, the ground speed for cruise is predicted to be:

115 Knot
- 10 Knot
105 Knot

Therefore, the time required for the cruise portion of the trip is:

$$\frac{449.9 \text{ NM}}{105 \text{ Kt}} = 4.3 \text{ hrs}$$

The fuel required for cruise is:

$$4.3 \text{ h} \times 22.1 \text{ l/h} = 95.0 \text{ l (25.1 US gal)}$$

The total estimated fuel required is as follows:

Engine Start, Taxi and Takeoff 4.0 l (1.1 US gal)
Climb..... + 4.4 l (1.2 US gal)
Cruise..... + 95.0 l (25.1 US gal)
Total fuel required 103.4 l (27.4US gal)

This gives with full tanks a reserve of:

168.8 l (44.6 US gal)
- 103.4 l (27.3 US gal)
65.4 l (17.3 US gal)

Once the flight is underway, ground speed checks will provide a more accurate basis for estimating the time enroute and the corresponding fuel required.

LANDING DISTANCE

Refer to Pilot's Operating Handbook

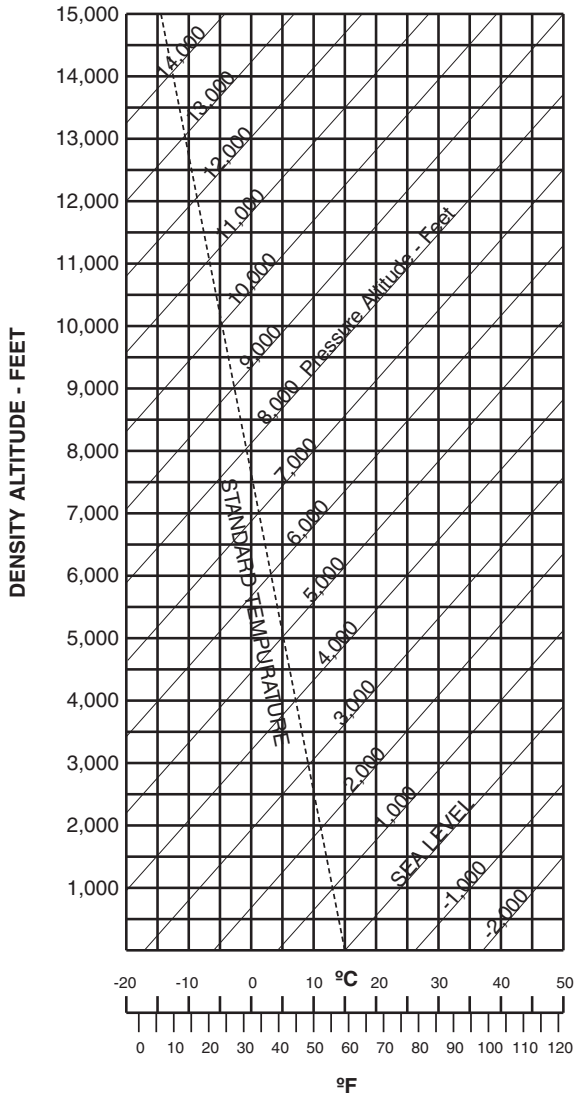

Figure 5-1 Density Altitude Chart

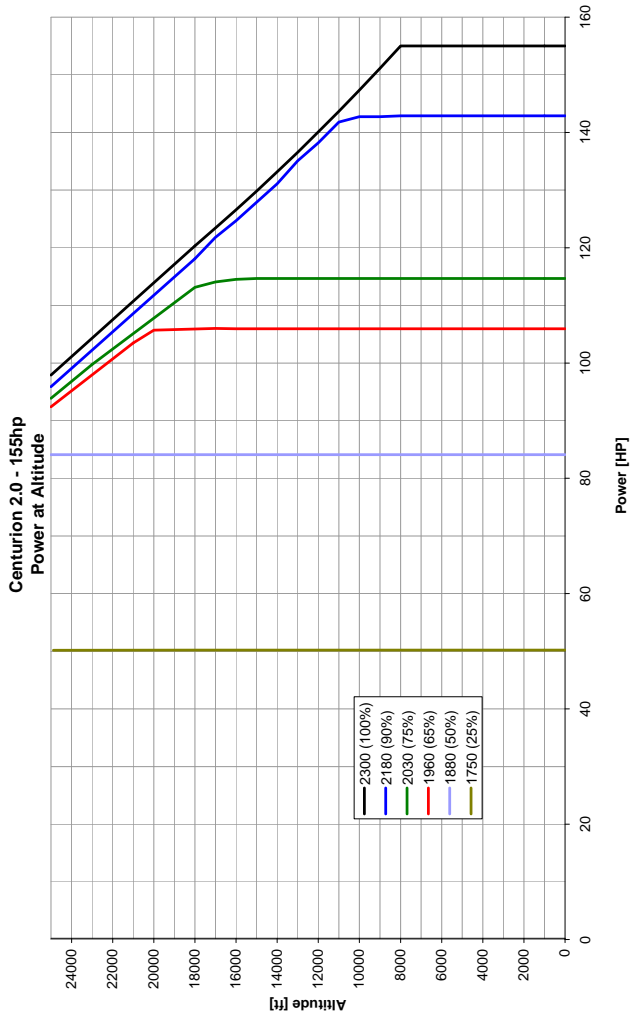

Figure 5-2 Engine Power Over Altitude

This page intentionally left blank

SECTION 5a PERFORMANCE

◆ Note: This chapter applies to aircraft with propellers **MTV-6-A/187-129**. The correct propeller designation can be found on the blades.

◆ Note: The chapter not relevant to the respective propeller can be omitted.

**GROUND ROLL AND TAKE-OFF DISTANCE
at 1157 kg (2550 lbs)****SHORT FIELD TAKEOFF****Conditions:**

Take-off weight 1157 kg (2550 lbs)

Flaps 10°

Full Power Prior to Brake Release

Paved, level, dry runway

Zero Wind

Lift Off: 51 KIAS

Speed at 15 m / 50 ft: 56 KIAS

Notes:

1. Short field technique
2. Decrease distances 10% for each 9 Knot headwind. For operation with tailwinds up to 10 Knot increase distances by 10% for each 2 Knot.
3. For operation on dry, grass runway, increase distances by 15% of the "ground roll" figure.
4. Consider additional distances (min. 20%) for wet grass runway, softened ground or snow.

PRESS ALT	Ground Roll and Take-Off Distance [m] Outside Air Temperature [°C]								
	[ft]	---	-20°C	0°C	10°C	20°C	30°C	40°C	50°C
0	Gnd Roll		225	260	278	297	322	357	402
	50 ft (15 m) obstacle		386	446	477	508	551	614	695
1000	Gnd Roll		241	279	298	318	344	382	431
	50 ft (15 m) obstacle		413	477	511	544	590	658	744
2000	Gnd Roll		259	299	320	341	369	410	462
	50 ft (15 m) obstacle		443	512	547	584	633	705	798
3000	Gnd Roll		277	321	343	366	396	440	495
	50 ft (15 m) obstacle		475	549	587	626	678	756	855
4000	Gnd Roll		298	344	368	392	425	472	531
	50 ft (15 m) obstacle		509	589	630	671	728	811	918
5000	Gnd Roll		319	369	395	421	456	506	570
	50 ft (15 m) obstacle		547	632	676	721	781	870	985
6000	Gnd Roll		343	396	424	452	490	544	612
	50 ft (15 m) obstacle		587	679	726	774	839	935	1058
7000	Gnd Roll		376	435	465	496	537	596	671
	50 ft (15 m) obstacle		644	744	796	849	920	1025	1160
8000	Gnd Roll		413	477	510	544	589	654	737
	50 ft (15 m) obstacle		707	817	873	931	1010	1125	1273
9000	Gnd Roll		458	529	566	604	654	726	818
	50 ft (15 m) obstacle		785	907	970	1034	1121	1249	1414
10000	Gnd Roll		509	588	629	671	727	807	908
	50 ft (15 m) obstacle		873	1008	1079	1150	1247	1389	1572

Figure 5-1a Take-Off Distance [m] at take-off weight 1157 kg (2550 lbs)

PRESS ALT	Ground Roll and Take-Off Distance [ft] Outside Air Temperature [°C]								
	[ft]	---	-20°C	0°C	10°C	20°C	30°C	40°C	50°C
0	Gnd Roll		739	854	913	974	1055	1171	1318
	50 ft (15 m) obstacle		1265	1461	1563	1667	1807	2013	2278
1000	Gnd Roll		792	915	978	1044	1130	1254	1413
	50 ft (15 m) obstacle		1355	1566	1675	1786	1936	2157	2441
2000	Gnd Roll		849	980	1049	1119	1211	1344	1514
	50 ft (15 m) obstacle		1452	1678	1795	1914	2075	2312	2616
3000	Gnd Roll		910	1051	1125	1199	1299	1442	1624
	50 ft (15 m) obstacle		1557	1799	1925	2053	2225	2479	2806
4000	Gnd Roll		976	1128	1207	1287	1393	1547	1742
	50 ft (15 m) obstacle		1671	1931	2065	2202	2387	2660	3010
5000	Gnd Roll		1048	1211	1295	1381	1496	1660	1870
	50 ft (15 m) obstacle		1794	2072	2217	2364	2563	2855	3231
6000	Gnd Roll		1125	1300	1391	1484	1606	1783	2008
	50 ft (15 m) obstacle		1926	2226	2381	2539	2752	3066	3470
7000	Gnd Roll		1234	1426	1525	1627	1761	1955	2202
	50 ft (15 m) obstacle		2112	2440	2610	2783	3018	3362	3805
8000	Gnd Roll		1354	1565	1674	1785	1933	2146	2416
	50 ft (15 m) obstacle		2318	2678	2865	3055	3312	3690	4176
9000	Gnd Roll		1503	1736	1857	1981	2145	2381	2681
	50 ft (15 m) obstacle		2574	2974	3181	3393	3678	4098	4638
10000	Gnd Roll		1670	1929	2064	2201	2383	2645	2979
	50 ft (15 m) obstacle		2863	3308	3538	3773	4090	4557	5157

Figure 5-1b Takeoff Distance [ft] at take-off weight 1157 kg (2550 lbs)

GROUND ROLL AND TAKE-OFF DISTANCE at 1134 kg (2500 lbs)

SHORT FIELD TAKEOFF

Conditions:

Take-off weight 1134 kg (2500 lbs)

Flaps 10°

Full Power Prior to Brake Release

Paved, level, dry runway

Zero Wind

Lift Off: 51 KIAS

Speed at 15 m / 50 ft: 56 KIAS

Notes:

1. Short field technique
2. Decrease distances 10% for each 9 Knot headwind. For operation with tailwinds up to 10 Knot increase distances by 10% for each 2 Knot.
3. For operation on dry, grass runway, increase distances by 15% of the "ground roll" figure.
4. Consider additional distances (min. 20%) for wet grass runway, softened ground or snow.

PRESS ALT	Ground Roll and Take-Off Distance [m] Outside Air Temperature [°C]								
	[ft]	---	-20°C	0°C	10°C	20°C	30°C	40°C	50°C
0	Gnd Roll		214	247	264	282	305	339	382
	50 ft (15 m) obstacle		366	423	452	482	523	583	659
1000	Gnd Roll		229	265	283	302	327	363	409
	50 ft (15 m) obstacle		392	453	485	517	560	624	706
2000	Gnd Roll		246	284	303	324	350	389	438
	50 ft (15 m) obstacle		420	486	519	554	600	669	757
3000	Gnd Roll		263	304	325	347	376	417	470
	50 ft (15 m) obstacle		451	521	557	594	644	717	812
4000	Gnd Roll		283	326	349	372	403	448	504
	50 ft (15 m) obstacle		484	559	598	637	691	770	871
5000	Gnd Roll		303	350	375	400	433	480	541
	50 ft (15 m) obstacle		519	600	641	684	742	826	935
6000	Gnd Roll		326	376	403	429	465	516	581
	50 ft (15 m) obstacle		557	644	689	735	796	887	1004
7000	Gnd Roll		357	413	441	471	510	566	637
	50 ft (15 m) obstacle		611	706	755	805	873	973	1101
8000	Gnd Roll		392	453	484	517	559	621	699
	50 ft (15 m) obstacle		671	775	829	884	958	1068	1208
9000	Gnd Roll		435	502	537	573	621	689	776
	50 ft (15 m) obstacle		745	861	921	982	1064	1186	1342
10000	Gnd Roll		483	558	597	637	690	766	862
	50 ft (15 m) obstacle		828	957	1024	1092	1184	1319	1492

Figure 5-1c Take-Off Distance [m] at take-off weight 1134 kg (2500 lbs)

PRESS ALT	Ground Roll and Take-Off Distance [ft] Outside Air Temperature [°C]								
	[ft]	---	-20°C	0°C	10°C	20°C	30°C	40°C	50°C
0	Gnd Roll		701	810	867	925	1001	1111	1251
	50 ft (15 m)		1200	1387	1484	1582	1715	1911	2163
1000	Gnd Roll		751	868	929	990	1072	1190	1341
	50 ft (15 m)		1286	1486	1589	1695	1837	2047	2317
2000	Gnd Roll		805	931	995	1062	1149	1276	1437
	50 ft (15 m)		1378	1593	1704	1817	1969	2194	2483
3000	Gnd Roll		864	998	1067	1138	1233	1368	1541
	50 ft (15 m)		1478	1708	1827	1948	2112	2353	2663
4000	Gnd Roll		927	1071	1145	1221	1322	1468	1653
	50 ft (15 m)		1586	1832	1960	2090	2266	2524	2857
5000	Gnd Roll		995	1149	1229	1311	1420	1576	1775
	50 ft (15 m)		1702	1967	2104	2244	2432	2710	3067
6000	Gnd Roll		1068	1234	1320	1408	1525	1692	1906
	50 ft (15 m)		1828	2112	2259	2410	2612	2910	3294
7000	Gnd Roll		1171	1353	1448	1544	1672	1856	2090
	50 ft (15 m)		2005	2316	2477	2642	2864	3191	3611
8000	Gnd Roll		1285	1485	1589	1694	1835	2037	2293
	50 ft (15 m)		2200	2542	2719	2899	3143	3502	3963
9000	Gnd Roll		1426	1648	1763	1880	2036	2260	2545
	50 ft (15 m)		2443	2823	3020	3220	3491	3889	4402
10000	Gnd Roll		1585	1831	1959	2089	2262	2511	2828
	50 ft (15 m)		2717	3139	3358	3581	3882	4325	4895

Figure 5-1d Take-Off Distance [ft] at take-off weight 1134 kg (2500 lbs)

**GROUND ROLL AND TAKE-OFF DISTANCE
at 1111 kg (2450 lbs)****SHORT FIELD TAKEOFF****Conditions:**

Take-off weight 1111 kg (2450 lbs)

Flaps 10°

Full Power Prior to Brake Release

Paved, level, dry runway

Zero Wind

Lift Off: 51 KIAS

Speed at 15 m / 50 ft: 56 KIAS

Notes:

1. Short field technique
2. Decrease distances 10% for each 9 Knot headwind. For operation with tailwinds up to 10 Knot increase distances by 10% for each 2 Knot.
3. For operation on dry, grass runway, increase distances by 15% of the "ground roll" figure.
4. Consider additional distances (min. 20%) for wet grass runway, softened ground or snow.

PRESS ALT	Ground Roll and Take-Off Distance [m] Outside Air Temperature [°C]								
	[ft]	---	-20°C	0°C	10°C	20°C	30°C	40°C	50°C
0	Gnd Roll		203	234	251	267	289	321	362
	50 ft (15 m) obstacle		347	401	429	457	496	552	625
1000	Gnd Roll		217	251	268	286	310	344	388
	50 ft (15 m) obstacle		372	430	459	490	531	592	670
2000	Gnd Roll		233	269	288	307	332	369	415
	50 ft (15 m) obstacle		398	460	492	525	569	634	718
3000	Gnd Roll		250	288	309	329	356	396	445
	50 ft (15 m) obstacle		427	494	528	563	610	680	770
4000	Gnd Roll		268	309	331	353	382	424	478
	50 ft (15 m) obstacle		458	530	567	604	655	730	826
5000	Gnd Roll		288	332	355	379	410	456	513
	50 ft (15 m) obstacle		492	569	608	649	703	783	887
6000	Gnd Roll		309	357	382	407	441	489	551
	50 ft (15 m) obstacle		528	611	653	696	755	841	952
7000	Gnd Roll		339	391	418	446	483	536	604
	50 ft (15 m) obstacle		579	670	716	764	828	922	1044
8000	Gnd Roll		372	429	459	490	530	589	663
	50 ft (15 m) obstacle		636	735	786	838	909	1012	1146
9000	Gnd Roll		412	476	510	544	588	653	736
	50 ft (15 m) obstacle		706	816	873	931	1009	1124	1272
10000	Gnd Roll		458	529	566	604	654	726	817
	50 ft (15 m) obstacle		785	907	971	1035	1122	1250	1415

Figure 5-1e Take-Off Distance [m] at take-off weight 1111 kg (2450 lbs)

PRESS ALT	Ground Roll and Take-Off Distance [ft] Outside Air Temperature [°C]							
	[ft]	---	-20°C	0°C	10°C	20°C	30°C	40°C
0	Gnd Roll	665	768	822	877	949	1054	1186
	50 ft (15 m) obstacle	1138	1315	1407	1500	1626	1812	2050
1000	Gnd Roll	712	823	881	939	1017	1129	1271
	50 ft (15 m) obstacle	1219	1409	1507	1607	1742	1941	2197
2000	Gnd Roll	764	882	944	1007	1090	1210	1362
	50 ft (15 m) obstacle	1307	1510	1615	1722	1867	2080	2354
3000	Gnd Roll	819	946	1012	1079	1169	1297	1461
	50 ft (15 m) obstacle	1401	1619	1732	1847	2002	2231	2525
4000	Gnd Roll	879	1015	1086	1158	1254	1392	1568
	50 ft (15 m) obstacle	1504	1737	1858	1982	2148	2393	2709
5000	Gnd Roll	943	1090	1166	1243	1346	1494	1683
	50 ft (15 m) obstacle	1614	1865	1995	2127	2306	2569	2908
6000	Gnd Roll	1013	1170	1252	1335	1445	1605	1807
	50 ft (15 m) obstacle	1733	2003	2142	2285	2477	2759	3123
7000	Gnd Roll	1110	1283	1372	1464	1585	1759	1981
	50 ft (15 m) obstacle	1901	2196	2349	2505	2716	3025	3424
8000	Gnd Roll	1219	1408	1506	1606	1739	1931	2174
	50 ft (15 m) obstacle	2086	2410	2578	2749	2980	3320	3758
9000	Gnd Roll	1352	1563	1671	1783	1930	2143	2413
	50 ft (15 m) obstacle	2317	2677	2863	3053	3310	3688	4173
10000	Gnd Roll	1503	1736	1857	1981	2144	2381	2681
	50 ft (15 m) obstacle	2576	2976	3184	3395	3681	4101	4641

Figure 5-1f Take-Off Distance [ft] at take-off weight 1111 kg (2450 lbs)

TIME, FUEL AND DISTANCE TO CLIMB AT 1157 kg (2550 lbs)

Conditions:

Takeoff weight 1157 kg (2550 lbs)

Climb speed $v_y = 70$ KIAS

Flaps Up

Full Power

Notes:

1. Add 4 l (1.1 US gal) of fuel for engine start, taxi and takeoff allowance.
2. Increase time and distance by 10% for 10°C above standard temperature.
3. Distances shown are based on zero wind.
4. Time, distance and fuel required are only valid from the point where the airplane climbs at $v_y = 70$ KIAS.

Press. Alt. [ft]	OAT [°C]	Vy [KIAS]	ROC [FPM]	Time [MIN]	Distance [NM]	Fuel used	
						[l]	[US Gal]
0	15	70	712	0.0	0.0	0.0	0.0
1000	13	70	706	1.4	1.7	0.8	0.2
2000	11	70	700	2.8	3.4	1.6	0.4
3000	9	70	693	4.3	5.2	2.4	0.6
4000	7	70	687	5.7	7.0	3.2	0.8
5000	5	70	680	7.2	9.0	4.0	1.1
6000	3	70	674	8.7	11.0	4.8	1.3
7000	1	70	667	10.1	13.1	5.7	1.5
8000	-1	70	660	11.7	15.3	6.5	1.7
9000	-3	70	630	13.2	17.6	7.2	1.9
10000	-5	70	600	14.8	20.1	7.9	2.1
11000	-7	70	571	16.5	22.7	8.6	2.3
12000	-9	70	541	18.3	25.6	9.3	2.4
13000	-11	70	510	20.2	28.7	10.0	2.6
14000	-13	70	480	22.3	32.1	10.6	2.8
15000	-15	70	449	24.4	35.8	11.4	3.0
16000	-17	70	418	26.7	39.9	12.1	3.2
17000	-19	70	387	29.2	44.3	12.8	3.4
18000	-21	70	356	31.9	49.2	13.6	3.6

Figure 5-2a Time, Fuel and Distance to Climb at 1157 kg (2550 lbs)

TIME, FUEL AND DISTANCE TO CLIMB AT 1134 kg (2500 lbs)

Conditions:

Takeoff weight 1134 kg (2500 lbs)

Climb speed $v_y = 70$ KIAS

Flaps Up

Full Power

Standard Temperature (ISA)

Notes:

1. Add 4 l (1.1 US gal) of fuel for engine start, taxi and takeoff allowance.
2. Increase time and distance by 10% for 10°C above standard temperature.
3. Distances shown are based on zero wind.
4. Time, distance and fuel required are only valid from the point where the airplane climbs at $v_y = 70$ KIAS.

Press. Alt. [ft]	OAT [°C]	Vy [KIAS]	ROC [FPM]	Time [MIN]	Distance [NM]	Fuel used	
						[l]	[US Gal]
0	15	70	739	0.0	0.0	0.0	0.0
1000	13	70	733	1.4	1.6	0.8	0.2
2000	11	70	727	2.7	3.3	1.5	0.4
3000	9	70	720	4.1	5.0	2.3	0.6
4000	7	70	714	5.5	6.8	3.1	0.8
5000	5	70	707	6.9	8.7	3.9	1.0
6000	3	70	701	8.3	10.6	4.7	1.2
7000	1	70	694	9.8	12.6	5.5	1.4
8000	-1	70	687	11.2	14.7	6.3	1.7
9000	-3	70	657	12.7	16.9	6.9	1.8
10000	-5	70	627	14.3	19.3	7.6	2.0
11000	-7	70	597	15.9	21.9	8.2	2.2
12000	-9	70	566	17.6	24.6	8.9	2.4
13000	-11	70	536	19.4	27.6	9.6	2.5
14000	-13	70	505	21.4	30.8	10.2	2.7
15000	-15	70	474	23.4	34.3	10.9	2.9
16000	-17	70	443	25.6	38.2	11.6	3.1
17000	-19	70	411	27.9	42.4	12.2	3.2
18000	-21	70	380	30.5	47.0	12.9	3.4

Figure 5-2b Time, Fuel and Distance to Climb at 1134 kg (2500 lbs)

TIME, FUEL AND DISTANCE TO CLIMB AT 1111 kg (2450 lbs)

Conditions:

Takeoff weight 1111 kg (2450 lbs)

Climb speed $v_y = 70$ KIAS

Flaps Up

Full Power

Standard Temperature (ISA)

Notes:

1. Add 4 l (1.1 US gal) of fuel for engine start, taxi and takeoff allowance.
2. Increase time and distance by 10% for 10°C above standard temperature.
3. Distances shown are based on zero wind.
4. Time, distance and fuel required are only valid from the point where the airplane climbs at $v_y = 70$ KIAS.

Press. Alt. [ft]	OAT [°C]	Vy [KIAS]	ROC [FPM]	Time [MIN]	Distance [NM]	Fuel used	
						[l]	[US Gal]
0	15	70	766	0.0	0.0	0.0	0.0
1000	13	70	760	1.3	1.5	0.7	0.2
2000	11	70	754	2.6	3.1	1.5	0.4
3000	9	70	748	4.0	4.8	2.2	0.6
4000	7	70	742	5.3	6.5	3.0	0.8
5000	5	70	736	6.7	8.3	3.7	1.0
6000	3	70	729	8.0	10.2	4.5	1.2
7000	1	70	722	9.4	12.1	5.2	1.4
8000	-1	70	715	10.8	14.1	6.0	1.6
9000	-3	70	685	12.2	16.3	6.7	1.8
10000	-5	70	654	13.7	18.5	7.3	1.9
11000	-7	70	624	15.3	21.0	7.9	2.1
12000	-9	70	593	16.9	23.6	8.5	2.3
13000	-11	70	562	18.7	26.5	9.2	2.4
14000	-13	70	531	20.5	29.6	9.8	2.6
15000	-15	70	499	22.4	32.9	10.4	2.8
16000	-17	70	468	24.5	36.5	11.1	2.9
17000	-19	70	436	26.7	40.5	11.7	3.1
18000	-21	70	404	29.1	44.9	12.4	3.3

Figure 5-2c Time, Fuel and Distance to Climb at 1111 kg (2450 lbs)

MAXIMUM RATE-OF-CLIMB at 1157 kg (2550 lbs)

Conditions:

Take-off weight 1157 kg (2550 lbs)

Climb speed $v_y = 70$ KIAS

Flaps Up

Full Power

Notes:

1. For operation in air colder than this table provides, use coldest data shown.
2. For operation in air warmer than this table provides, use extreme caution.

PRESS ALT [FT]	Climb speed [KIAS]	Rate of Climb [ft/min]				
		Outside Air Temperature [°C]				
		-20°C	0°C	+20°C	+40°C	+50°C
0	70	737	723	708	575	457
1000	70	730	715	701	567	449
2000	70	723	708	693	559	441
3000	70	716	700	685	551	433
4000	70	708	692	677	543	424
5000	70	701	684	669	534	415
6000	70	693	676	660	525	406
7000	70	685	668	652	516	397
8000	70	676	659	643	507	388
9000	70	645	628	611	477	360
10000	70	614	596	579	448	333
11000	70	583	564	547	418	305
12000	70	551	532	515	387	276
13000	70	519	500	482	357	248
14000	70	487	468	449	326	219
15000	70	454	435	416	295	190
16000	70	422	402	382	263	160
17000	70	389	368	348	231	131
18000	70	355	334	314	199	100

Figure 5-3a Maximum Rate of Climb at take-off weight
 1157 kg (2550 lbs)

MAXIMUM RATE-OF-CLIMB at 1134 kg (2500 lbs)

Conditions:

Take-off weight 1134 kg (2500 lbs)

Climb speed $v_y = 70$ KIAS

Flaps Up

Full Power

Notes:

1. For operation in air colder than this table provides, use coldest data shown.
2. For operation in air warmer than this table provides, use extreme caution.

PRESS ALT [FT]	Climb speed [KIAS]	Rate of Climb [ft/min]				
		Outside Air Temperature [°C]				
		-20°C	0°C	+20°C	+40°C	+50°C
0	70	764	749	735	599	479
1000	70	757	742	728	592	471
2000	70	750	735	720	584	463
3000	70	743	727	712	576	455
4000	70	735	719	704	568	447
5000	70	727	711	696	559	438
6000	70	720	703	688	550	429
7000	70	712	695	679	541	420
8000	70	703	686	670	532	411
9000	70	672	655	638	502	383
10000	70	640	623	606	472	355
11000	70	609	591	573	442	327
12000	70	577	558	541	411	298
13000	70	544	526	508	380	270
14000	70	512	493	474	349	241
15000	70	479	460	441	318	211
16000	70	446	426	407	286	181
17000	70	413	392	373	254	151
18000	70	379	358	338	221	121

Figure 5-3b Maximum Rate of Climb at take-off weight
1134 kg (2500 lbs)

MAXIMUM RATE-OF-CLIMB at 1111 kg (2450 lbs)

Conditions:

Take-off weight 1111 kg (2450 lbs)

Climb speed $v_y = 70$ KIAS

Flaps Up

Full Power

Notes:

1. For operation in air colder than this table provides, use coldest data shown.
2. For operation in air warmer than this table provides, use extreme caution.

PRESS ALT [FT]	Climb speed [KIAS]	Rate of Climb [ft/min]				
		Outside Air Temperature [°C]				
		-20°C	0°C	+20°C	+40°C	+50°C
0	70	791	777	763	625	502
1000	70	784	770	756	617	495
2000	70	777	762	748	609	487
3000	70	770	755	740	601	479
4000	70	763	747	732	593	470
5000	70	755	739	724	585	462
6000	70	748	731	716	576	453
7000	70	740	723	707	567	444
8000	70	731	715	698	558	435
9000	70	700	683	666	528	407
10000	70	668	650	633	498	378
11000	70	636	618	601	467	350
12000	70	603	585	568	436	321
13000	70	571	552	534	405	292
14000	70	538	519	501	373	263
15000	70	504	485	467	341	233
16000	70	471	451	432	309	203
17000	70	437	417	398	277	173
18000	70	403	383	363	244	142

Figure 5-3c Maximum Rate of Climb at take-off weight
 1111 kg (2450 lbs)

**CRUISE PERFORMANCE, RANGE AND ENDURANCE at
1157 kg (2550 lbs)****Conditions:**

Take-off weight 1157 kg (2550 lbs)
Flaps Up
Zero wind

Notes:

1. Endurance information are based on 168.8 l (44.6 US gal) usable fuel.
2. The table assumes 4 l (1.1 US gal) for startup and taxi; time, fuel and distance to climb and 45 min. reserve.
3. Increase true airspeed (KTAS) and maximum range (NM) by 1% per 10°C above ISA temperature.
4. Cruise Power above 75% not recommended. For economic cruise set load 70% or less.

Press. Alt.	Load	Speed		Fuel Flow		Distance	Endu- rance Time
		[KTAS]	[mph]	[l/h]	[US Gal/h]		
SL	100	123	142	33.6	8.9	511	4.2
SL	90	118	136	29.6	7.8	568	4.8
SL	80	113	130	25.8	6.8	637	5.6
SL	70	106	122	22.1	5.8	711	6.7
SL	60	99	114	18.6	4.9	803	8.1
SL	50	90	104	15.3	4.0	902	10.0
2000	100	126	145	33.6	8.9	521	4.1
2000	90	120	138	29.6	7.8	575	4.7
2000	80	114	131	25.8	6.8	639	5.5
2000	70	108	124	22.1	5.8	720	6.6
2000	60	100	115	18.6	4.9	806	8.0
2000	50	91	105	15.3	4.0	906	9.9
4000	100	128	147	33.6	8.9	526	4.0
4000	90	122	140	29.6	7.8	581	4.6
4000	80	116	133	25.8	6.8	646	5.4
4000	70	110	127	22.1	5.8	729	6.5
4000	60	102	117	18.6	4.9	817	7.8
4000	50	92	106	15.3	4.0	910	9.7
6000	100	130	150	33.6	8.9	532	3.9
6000	90	125	144	29.6	7.8	592	4.5
6000	80	118	136	25.8	6.8	654	5.3
6000	70	111	128	22.1	5.8	731	6.3
6000	60	103	119	18.6	4.9	819	7.7
6000	50	93	107	15.3	4.0	913	9.6
8000	100	133	153	33.6	8.9	541	3.8
8000	90	127	146	29.6	7.8	598	4.4
8000	80	120	138	25.8	6.8	661	5.2
8000	70	113	130	22.1	5.8	739	6.2
8000	60	105	121	18.6	4.9	829	7.6
8000	50	95	109	15.3	4.0	926	9.4
10000	90	129	148	29.6	7.8	604	4.3
10000	80	122	140	25.8	6.8	667	5.1

Press. Alt.	Load	Speed		Fuel Flow		Distance	Endu- rance Time
		[ft]	[%]	[KTAS]	[mph]		
10000	70	115	132	22.1	5.8	747	6.1
10000	60	106	122	18.6	4.9	831	7.4
10000	50	96	110	15.3	4.0	929	9.2
12000	90	131	151	29.6	7.8	610	4.2
12000	80	125	144	25.8	6.8	679	4.9
12000	70	117	135	22.1	5.8	755	5.9
12000	60	108	124	18.6	4.9	841	7.3
12000	50	97	112	15.3	4.0	932	9.1
14000	90	134	154	29.6	7.8	620	4.0
14000	80	127	146	25.8	6.8	686	4.8
14000	70	119	137	22.1	5.8	762	5.8
14000	60	109	125	18.6	4.9	843	7.1
14000	50	98	113	15.3	4.0	934	8.9
16000	80	129	148	25.8	6.8	692	4.7
16000	70	121	139	22.1	5.8	770	5.6
16000	60	111	128	18.6	4.9	852	6.9
16000	50	100	115	15.3	4.0	946	8.7
18000	80	131	151	25.8	6.8	699	4.5
18000	70	122	140	22.1	5.8	771	5.5
18000	60	113	130	18.6	4.9	860	6.7
18000	50	101	116	15.3	4.0	948	8.5

Figure 5-4a Cruise Performance, Range and Endurance at 1157 kg (2550 lbs)

CRUISE PERFORMANCE, RANGE AND ENDURANCE at 1134 kg (2500 lbs)

Conditions:

Take-off weight 1134 kg (2500 lbs)
Flaps Up
Zero wind

Notes:

1. Endurance information are based on 168.8 l (44.6 US gal) usable fuel.
2. The table assumes 4 l (1.1 US gal) for startup and taxi; time, fuel and distance to climb and 45 min. reserve.
3. Increase true airspeed (KTAS) and maximum range (NM) by 1% per 10°C above ISA temperature.
4. Cruise Power above 75% not recommended. For economic cruise set load 70% or less.

Press. Alt.	Load	Speed		Fuel Flow		Distance	Endu- rance Time
		[ft]	[%]	[KTAS]	[mph]		
SL	100	125	144	33.6	8.9	519	4.2
SL	90	120	138	29.6	7.8	577	4.8
SL	80	114	131	25.8	6.8	642	5.6
SL	70	107	124	22.1	5.8	721	6.7
SL	60	100	115	18.6	4.9	813	8.1
SL	50	92	105	15.3	4.0	918	10.0
2000	100	127	146	33.6	8.9	526	4.1
2000	90	122	140	29.6	7.8	584	4.7
2000	80	116	133	25.8	6.8	649	5.5
2000	70	109	126	22.1	5.8	729	6.6
2000	60	102	117	18.6	4.9	821	8.0
2000	50	93	107	15.3	4.0	925	9.9
4000	100	129	149	33.6	8.9	533	4.0
4000	90	124	143	29.6	7.8	591	4.6
4000	80	118	136	25.8	6.8	657	5.4
4000	70	111	128	22.1	5.8	736	6.5
4000	60	103	119	18.6	4.9	828	7.9
4000	50	94	108	15.3	4.0	931	9.7
6000	100	132	152	33.6	8.9	540	3.9
6000	90	126	145	29.6	7.8	598	4.5
6000	80	120	138	25.8	6.8	665	5.3
6000	70	113	130	22.1	5.8	744	6.4
6000	60	105	121	18.6	4.9	836	7.7
6000	50	95	110	15.3	4.0	937	9.6
8000	100	134	154	33.6	8.9	547	3.8
8000	90	128	148	29.6	7.8	605	4.4
8000	80	122	140	25.8	6.8	672	5.2
8000	70	115	132	22.1	5.8	752	6.2
8000	60	107	123	18.6	4.9	843	7.6
8000	50	97	111	15.3	4.0	943	9.4
10000	90	131	150	29.6	7.8	613	4.3
10000	80	124	143	25.8	6.8	680	5.1

Press. Alt.	Load	Speed		Fuel Flow		Distance	Endurance Time
		[ft]	[%]	[KTAS]	[mph]		
10000	70	117	134	22.1	5.8	760	6.1
10000	60	108	125	18.6	4.9	850	7.4
10000	50	98	113	15.3	4.0	948	9.3
12000	90	133	153	29.6	7.8	620	4.2
12000	80	126	145	25.8	6.8	688	5.0
12000	70	119	137	22.1	5.8	767	6.0
12000	60	110	127	18.6	4.9	858	7.3
12000	50	99	114	15.3	4.0	952	9.1
14000	88	134	154	28.9	7.6	639	4.2
14000	80	129	148	25.8	6.8	696	4.8
14000	70	121	139	22.1	5.8	775	5.8
14000	60	112	128	18.6	4.9	865	7.1
14000	50	100	115	15.3	4.0	956	8.9
16000	84	134	154	27.6	7.3	668	4.3
16000	80	131	151	25.8	6.8	704	4.7
16000	70	123	141	22.1	5.8	783	5.7
16000	60	113	130	18.6	4.9	871	7.0
16000	50	101	116	15.3	4.0	958	8.7
18000	80	133	153	25.8	6.8	712	4.6
18000	70	125	144	22.1	5.8	791	5.5
18000	60	115	132	18.6	4.9	877	6.8
18000	50	102	117	15.3	4.0	959	8.5

Figure 5-4b Cruise Performance, Range and Endurance
 at 1134 kg (2500 lbs)

**CRUISE PERFORMANCE, RANGE AND ENDURANCE at
1111 kg (2450 lbs)****Conditions:**

Take-off weight 1111kg (2450 lbs)

Flaps Up

Zero wind

Notes:

1. Endurance information are based on 168.8 l (44.6 US gal) usable fuel.
2. The table assumes 4 l (1.1 US gal) for startup and taxi; time, fuel and distance to climb and 45 min. reserve.
3. Increase true airspeed (KTAS) and maximum range (NM) by 1% per 10°C above ISA temperature.
4. Cruise Power above 75% not recommended. For economic cruise set load 70% or less.

Press. Alt.	Load	Speed		Fuel Flow		Distance	Endu- rance Time
		[KTAS]	[mph]	[l/h]	[US Gal/h]		
SL	100	126	145	33.6	8.9	524	4.2
SL	90	121	139	29.6	7.8	583	4.8
SL	80	116	133	25.8	6.8	654	5.6
SL	70	109	125	22.1	5.8	731	6.7
SL	60	102	117	18.6	4.9	827	8.1
SL	50	93	107	15.3	4.0	932	10.0
2000	100	129	148	33.6	8.9	533	4.1
2000	90	123	142	29.6	7.8	590	4.7
2000	80	118	136	25.8	6.8	662	5.5
2000	70	111	128	22.1	5.8	740	6.6
2000	60	103	119	18.6	4.9	830	8.0
2000	50	94	108	15.3	4.0	936	9.9
4000	100	131	151	33.6	8.9	539	4.0
4000	90	126	145	29.6	7.8	601	4.6
4000	80	120	138	25.8	6.8	669	5.4
4000	70	113	130	22.1	5.8	749	6.5
4000	60	105	121	18.6	4.9	841	7.9
4000	50	95	109	15.3	4.0	940	9.7
6000	100	133	153	33.6	8.9	545	3.9
6000	90	128	147	29.6	7.8	607	4.5
6000	80	122	140	25.8	6.8	676	5.3
6000	70	115	132	22.1	5.8	758	6.4
6000	60	106	122	18.6	4.9	844	7.7
6000	50	97	112	15.3	4.0	953	9.6
8000	100	136	157	33.6	8.9	554	3.8
8000	90	130	150	29.6	7.8	613	4.4
8000	80	124	143	25.8	6.8	683	5.2
8000	70	116	133	22.1	5.8	760	6.3
8000	60	108	124	18.6	4.9	854	7.6
8000	50	98	113	15.3	4.0	957	9.4
10000	90	133	153	29.6	7.8	624	4.3
10000	80	126	145	25.8	6.8	690	5.1

Press. Alt.	Load	Speed		Fuel Flow		Distance	Endurance Time
		[ft]	[%]	[KTAS]	[mph]		
10000	70	118	136	22.1	5.8	768	6.1
10000	60	110	127	18.6	4.9	864	7.5
10000	50	99	114	15.3	4.0	960	9.3
12000	90	135	155	29.6	7.8	630	4.2
12000	80	128	147	25.8	6.8	697	5.0
12000	70	120	138	22.1	5.8	776	6.0
12000	60	111	128	18.6	4.9	866	7.3
12000	50	101	116	15.3	4.0	972	9.1
14000	90	137	158	29.6	7.8	635	4.1
14000	80	130	150	25.8	6.8	704	4.9
14000	70	122	140	22.1	5.8	784	5.9
14000	60	113	130	18.6	4.9	876	7.2
14000	50	102	117	15.3	4.0	975	9.0
16000	80	133	153	25.8	6.8	716	4.7
16000	70	124	143	22.1	5.8	792	5.7
16000	60	115	132	18.6	4.9	885	7.0
16000	50	103	119	15.3	4.0	978	8.8
18000	80	135	155	25.8	6.8	722	4.6
18000	70	126	145	22.1	5.8	799	5.6
18000	60	116	133	18.6	4.9	887	6.8
18000	50	105	121	15.3	4.0	989	8.6

Figure 5-4c Cruise Performance, Range and Endurance at 1111 kg (2450 lbs)

SECTION 5b PERFORMANCE

◆ Note: This chapter applies to aircraft with propellers **MTV-6-A/190-69**. The correct propeller designation can be found on the blades.

◆ Note: The chapter not relevant to the respective propeller can be omitted.

**GROUND ROLL AND TAKE-OFF DISTANCE
at 1157 kg (2550 lbs)****SHORT FIELD TAKEOFF****Conditions:**

Take-off weight 1157 kg (2550 lbs)

Flaps 10°

Full Power Prior to Brake Release

Paved, level, dry runway

Zero Wind

Lift Off: 51 KIAS

Speed at 15 m / 50 ft: 56 KIAS

Notes:

1. Short field technique
2. Decrease distances 10% for each 9 Knot headwind. For operation with tailwinds up to 10 Knot increase distances by 10% for each 2 Knot.
3. For operation on dry, grass runway, increase distances by 15% of the "ground roll" figure.
4. Consider additional distances (min. 20%) for wet grass runway, softened ground or snow.

PRESS ALT	Ground Roll and Take-Off Distance [m] Outside Air Temperature [°C]								
	[ft]	---	-20°C	0°C	10°C	20°C	30°C	40°C	50°C
0	Gnd Roll		201	232	248	266	284	313	352
	50 ft (15 m) obstacle		314	362	388	417	445	491	555
1000	Gnd Roll		215	248	266	285	305	335	377
	50 ft (15 m) obstacle		336	388	416	447	477	526	594
2000	Gnd Roll		230	266	285	306	326	359	404
	50 ft (15 m) obstacle		360	416	446	479	511	564	637
3000	Gnd Roll		247	285	306	328	350	385	434
	50 ft (15 m) obstacle		386	446	478	513	548	604	683
4000	Gnd Roll		265	306	328	352	376	413	465
	50 ft (15 m) obstacle		414	479	513	551	588	649	733
5000	Gnd Roll		284	329	352	378	403	444	499
	50 ft (15 m) obstacle		445	514	550	591	631	696	787
6000	Gnd Roll		305	353	378	406	433	477	536
	50 ft (15 m) obstacle		478	552	591	635	678	748	845
7000	Gnd Roll		335	387	414	445	475	522	588
	50 ft (15 m) obstacle		524	605	648	696	743	819	926
8000	Gnd Roll		367	424	454	487	520	573	644
	50 ft (15 m) obstacle		574	663	710	763	814	898	1015
9000	Gnd Roll		406	470	503	540	576	634	713
	50 ft (15 m) obstacle		636	735	787	845	902	996	1125
10000	Gnd Roll		450	520	557	598	638	703	790
	50 ft (15 m) obstacle		705	815	873	937	1000	1104	1247

Figure 5-1a Take-Off Distance [m] at take-off weight 1157 kg (2550 lbs)

PRESS ALT	Ground Roll and Take-Off Distance [ft] Outside Air Temperature [°C]							
	[ft]	---	-20°C	0°C	10°C	20°C	30°C	40°C
0	Gnd Roll	658	760	814	874	932	1026	1155
	50 ft (15 m) obstacle	1029	1189	1273	1367	1459	1610	1819
1000	Gnd Roll	705	814	872	936	999	1100	1237
	50 ft (15 m) obstacle	1102	1274	1364	1465	1563	1725	1949
2000	Gnd Roll	755	873	934	1003	1071	1179	1326
	50 ft (15 m) obstacle	1182	1365	1462	1570	1676	1849	2089
3000	Gnd Roll	810	936	1002	1076	1148	1264	1422
	50 ft (15 m) obstacle	1267	1464	1567	1683	1797	1983	2240
4000	Gnd Roll	869	1004	1075	1154	1232	1356	1526
	50 ft (15 m) obstacle	1359	1571	1682	1806	1928	2127	2404
5000	Gnd Roll	933	1078	1154	1239	1322	1456	1638
	50 ft (15 m) obstacle	1459	1686	1805	1939	2070	2283	2580
6000	Gnd Roll	1002	1158	1239	1331	1420	1563	1759
	50 ft (15 m) obstacle	1567	1811	1939	2082	2223	2452	2771
7000	Gnd Roll	1098	1269	1358	1458	1557	1713	1928
	50 ft (15 m) obstacle	1718	1985	2125	2282	2436	2688	3037
8000	Gnd Roll	1204	1391	1489	1599	1706	1878	2113
	50 ft (15 m) obstacle	1883	2175	2329	2501	2670	2946	3329
9000	Gnd Roll	1333	1540	1649	1770	1890	2080	2340
	50 ft (15 m) obstacle	2087	2411	2581	2772	2959	3265	3690
10000	Gnd Roll	1477	1706	1827	1961	2094	2304	2593
	50 ft (15 m) obstacle	2313	2673	2862	3074	3281	3620	4091

Figure 5-1b Takeoff Distance [ft] at take-off weight 1157 kg (2550 lbs)

GROUND ROLL AND TAKE-OFF DISTANCE at 1134 kg (2500 lbs)

SHORT FIELD TAKEOFF

Conditions:

Take-off weight 1134 kg (2500 lbs)

Flaps 10°

Full Power Prior to Brake Release

Paved, level, dry runway

Zero Wind

Lift Off: 51 KIAS

Speed at 15 m / 50 ft: 56 KIAS

Notes:

1. Short field technique
2. Decrease distances 10% for each 9 Knot headwind. For operation with tailwinds up to 10 Knot increase distances by 10% for each 2 Knot.
3. For operation on dry, grass runway, increase distances by 15% of the "ground roll" figure.
4. Consider additional distances (min. 20%) for wet grass runway, softened ground or snow.

PRESS ALT	Ground Roll and Take-Off Distance [m] Outside Air Temperature [°C]								
	[ft]	---	-20°C	0°C	10°C	20°C	30°C	40°C	50°C
0	Gnd Roll		191	220	236	253	270	297	334
	50 ft (15 m) obstacle		298	344	369	396	423	466	527
1000	Gnd Roll		204	236	253	271	289	318	358
	50 ft (15 m) obstacle		319	369	395	424	453	500	565
2000	Gnd Roll		219	253	271	291	310	341	384
	50 ft (15 m) obstacle		342	395	423	455	485	536	605
3000	Gnd Roll		235	271	290	312	333	366	412
	50 ft (15 m) obstacle		367	424	454	488	520	574	649
4000	Gnd Roll		252	291	311	334	357	393	442
	50 ft (15 m) obstacle		394	455	487	523	558	616	696
5000	Gnd Roll		270	312	334	359	383	422	474
	50 ft (15 m) obstacle		423	488	523	561	599	661	747
6000	Gnd Roll		290	335	359	385	411	453	509
	50 ft (15 m) obstacle		454	524	562	603	644	710	803
7000	Gnd Roll		318	367	393	423	451	496	558
	50 ft (15 m) obstacle		497	575	615	661	706	778	880
8000	Gnd Roll		349	403	431	464	494	544	612
	50 ft (15 m) obstacle		545	630	675	726	773	853	964
9000	Gnd Roll		386	446	478	515	547	602	678
	50 ft (15 m) obstacle		604	698	748	806	857	946	1069
10000	Gnd Roll		428	494	529	572	606	667	751
	50 ft (15 m) obstacle		670	774	829	896	950	1049	1185

Figure 5-1c Take-Off Distance [m] at take-off weight 1134 kg (2500 lbs)

PRESS ALT	Ground Roll and Take-Off Distance [ft] Outside Air Temperature [°C]								
	[ft]	---	-20°C	0°C	10°C	20°C	30°C	40°C	50°C
0	Gnd Roll		625	722	773	830	886	975	1097
	50 ft (15 m)		977	1129	1209	1299	1386	1530	1728
1000	Gnd Roll		669	774	828	889	949	1045	1175
	50 ft (15 m)		1047	1210	1296	1391	1485	1639	1852
2000	Gnd Roll		718	829	888	953	1017	1120	1260
	50 ft (15 m)		1122	1297	1389	1491	1592	1756	1985
3000	Gnd Roll		769	889	952	1022	1091	1201	1351
	50 ft (15 m)		1204	1391	1489	1599	1707	1884	2128
4000	Gnd Roll		826	954	1021	1096	1170	1288	1449
	50 ft (15 m)		1291	1492	1598	1716	1832	2021	2283
5000	Gnd Roll		886	1024	1096	1177	1256	1383	1556
	50 ft (15 m)		1386	1602	1715	1842	1966	2169	2451
6000	Gnd Roll		952	1100	1177	1264	1349	1485	1671
	50 ft (15 m)		1489	1720	1842	1978	2111	2330	2632
7000	Gnd Roll		1043	1205	1290	1386	1479	1628	1831
	50 ft (15 m)		1632	1885	2019	2169	2314	2553	2885
8000	Gnd Roll		1143	1321	1415	1521	1621	1784	2007
	50 ft (15 m)		1789	2067	2213	2380	2537	2799	3163
9000	Gnd Roll		1266	1463	1567	1688	1795	1976	2223
	50 ft (15 m)		1982	2290	2452	2643	2811	3102	3505
10000	Gnd Roll		1403	1621	1736	1875	1989	2189	2463
	50 ft (15 m)		2198	2539	2719	2939	3117	3439	3886

Figure 5-1d Take-Off Distance [ft] at take-off weight 1134 kg (2500 lbs)

**GROUND ROLL AND TAKE-OFF DISTANCE
at 1111 kg (2450 lbs)****SHORT FIELD TAKEOFF****Conditions:**

Take-off weight 1111 kg (2450 lbs)

Flaps 10°

Full Power Prior to Brake Release

Paved, level, dry runway

Zero Wind

Lift Off: 51 KIAS

Speed at 15 m / 50 ft: 56 KIAS

Notes:

1. Short field technique
2. Decrease distances 10% for each 9 Knot headwind. For operation with tailwinds up to 10 Knot increase distances by 10% for each 2 Knot.
3. For operation on dry, grass runway, increase distances by 15% of the "ground roll" figure.
4. Consider additional distances (min. 20%) for wet grass runway, softened ground or snow.

PRESS ALT	Ground Roll and Take-Off Distance [m] Outside Air Temperature [°C]								
	[ft]	---	-20°C	0°C	10°C	20°C	30°C	40°C	50°C
0	Gnd Roll		181	209	224	240	256	282	317
	50 ft (15 m) obstacle		283	327	350	376	401	442	500
1000	Gnd Roll		194	224	240	257	275	302	340
	50 ft (15 m) obstacle		303	350	375	402	430	474	536
2000	Gnd Roll		208	240	257	276	294	324	364
	50 ft (15 m) obstacle		325	375	402	431	460	508	574
3000	Gnd Roll		223	257	275	296	316	347	391
	50 ft (15 m) obstacle		348	402	431	463	494	545	616
4000	Gnd Roll		239	276	295	317	339	373	419
	50 ft (15 m) obstacle		374	432	462	496	530	585	661
5000	Gnd Roll		256	296	317	340	363	400	450
	50 ft (15 m) obstacle		401	463	496	533	569	627	709
6000	Gnd Roll		275	318	341	366	390	430	483
	50 ft (15 m) obstacle		431	498	533	572	611	674	761
7000	Gnd Roll		302	349	373	401	428	471	530
	50 ft (15 m) obstacle		472	545	584	627	669	739	835
8000	Gnd Roll		331	382	409	439	469	516	581
	50 ft (15 m) obstacle		517	598	640	687	734	810	915
9000	Gnd Roll		366	423	453	486	519	572	643
	50 ft (15 m) obstacle		573	663	709	762	813	897	1014
10000	Gnd Roll		406	469	502	539	575	633	712
	50 ft (15 m) obstacle		636	735	786	845	902	995	1124

Figure 5-1e Take-Off Distance [m] at take-off weight 1111 kg (2450 lbs)

PRESS ALT	Ground Roll and Take-Off Distance [ft] Outside Air Temperature [°C]								
	[ft]	---	-20°C	0°C	10°C	20°C	30°C	40°C	50°C
0	Gnd Roll		593	685	733	787	840	925	1041
	50 ft (15 m) obstacle		927	1072	1147	1232	1315	1451	1640
1000	Gnd Roll		635	734	786	844	900	991	1115
	50 ft (15 m) obstacle		994	1148	1229	1320	1409	1555	1757
2000	Gnd Roll		681	787	842	904	965	1062	1195
	50 ft (15 m) obstacle		1065	1230	1317	1415	1510	1667	1883
3000	Gnd Roll		730	844	903	970	1035	1139	1282
	50 ft (15 m) obstacle		1142	1319	1413	1517	1620	1787	2019
4000	Gnd Roll		783	905	969	1040	1110	1222	1375
	50 ft (15 m) obstacle		1225	1416	1516	1628	1738	1917	2167
5000	Gnd Roll		841	971	1040	1117	1192	1312	1476
	50 ft (15 m) obstacle		1315	1520	1627	1747	1865	2058	2326
6000	Gnd Roll		903	1043	1117	1199	1280	1409	1585
	50 ft (15 m) obstacle		1412	1632	1747	1877	2003	2210	2498
7000	Gnd Roll		990	1144	1224	1314	1403	1544	1737
	50 ft (15 m) obstacle		1548	1789	1915	2057	2196	2423	2737
8000	Gnd Roll		1085	1253	1342	1441	1538	1693	1905
	50 ft (15 m) obstacle		1697	1961	2099	2255	2407	2656	3001
9000	Gnd Roll		1201	1388	1486	1596	1703	1875	2109
	50 ft (15 m) obstacle		1881	2173	2327	2499	2667	2943	3326
10000	Gnd Roll		1331	1538	1647	1768	1887	2077	2337
	50 ft (15 m) obstacle		2085	2409	2580	2770	2957	3263	3687

Figure 5-1f Take-Off Distance [ft] at take-off weight 1111 kg (2450 lbs)

TIME, FUEL AND DISTANCE TO CLIMB AT 1157 kg (2550 lbs)

Conditions:

Takeoff weight 1157 kg (2550 lbs)

Climb speed $v_y = 70$ KIAS

Flaps Up

Full Power

Notes:

1. Add 4 l (1.1 US gal) of fuel for engine start, taxi and takeoff allowance.
2. Increase time and distance by 10% for 10°C above standard temperature.
3. Distances shown are based on zero wind.
4. Time, distance and fuel required are only valid from the point where the airplane climbs at $v_y = 70$ KIAS.

Press. Alt. [ft]	OAT [°C]	Vy [KIAS]	ROC [FPM]	Time [MIN]	Distance [NM]	Fuel used	
						[l]	[US Gal]
0	15	70	767	0.0	0.0	0.0	0.0
1000	13	70	761	1.3	1.5	0.7	0.2
2000	11	70	755	2.6	3.1	1.5	0.4
3000	9	70	748	4.0	4.8	2.2	0.6
4000	7	70	742	5.3	6.5	3.0	0.8
5000	5	70	736	6.7	8.3	3.7	1.0
6000	3	70	729	8.0	10.2	4.5	1.2
7000	1	70	722	9.4	12.1	5.3	1.4
8000	-1	70	715	10.8	14.1	6.0	1.6
9000	-3	70	685	12.2	16.3	6.7	1.8
10000	-5	70	654	13.7	18.5	7.3	1.9
11000	-7	70	623	15.3	21.0	7.9	2.1
12000	-9	70	592	16.9	23.6	8.6	2.3
13000	-11	70	561	18.7	26.5	9.2	2.4
14000	-13	70	530	20.5	29.6	9.8	2.6
15000	-15	70	498	22.4	32.9	10.5	2.8
16000	-17	70	466	24.5	36.6	11.1	2.9
17000	-19	70	434	26.7	40.5	11.8	3.1
18000	-21	70	402	29.1	44.9	12.4	3.3

Figure 5-2a Time, Fuel and Distance to Climb at 1157 kg (2550 lbs)

TIME, FUEL AND DISTANCE TO CLIMB AT 1134 kg (2500 lbs)

Conditions:

Takeoff weight 1134 kg (2500 lbs)

Climb speed $v_y = 70$ KIAS

Flaps Up

Full Power

Standard Temperature (ISA)

Notes:

1. Add 4 l (1.1 US gal) of fuel for engine start, taxi and takeoff allowance.
2. Increase time and distance by 10% for 10°C above standard temperature.
3. Distances shown are based on zero wind.
4. Time, distance and fuel required are only valid from the point where the airplane climbs at $v_y = 70$ KIAS.

Press. Alt. [ft]	OAT [°C]	Vy [KIAS]	ROC [FPM]	Time [MIN]	Distance [NM]	Fuel used	
						[l]	[US Gal]
0	15	70	794	0.0	0.0	0.0	0.0
1000	13	70	788	1.3	1.5	0.7	0.2
2000	11	70	782	2.5	3.0	1.4	0.4
3000	9	70	776	3.8	4.6	2.1	0.6
4000	7	70	770	5.1	6.3	2.9	0.8
5000	5	70	763	6.4	8.0	3.6	0.9
6000	3	70	757	7.7	9.8	4.3	1.1
7000	1	70	750	9.1	11.7	5.1	1.3
8000	-1	70	743	10.4	13.6	5.8	1.5
9000	-3	70	712	11.8	15.7	6.4	1.7
10000	-5	70	681	13.2	17.9	7.0	1.9
11000	-7	70	650	14.7	20.2	7.7	2.0
12000	-9	70	618	16.3	22.7	8.3	2.2
13000	-11	70	587	18.0	25.5	8.9	2.3
14000	-13	70	555	19.7	28.4	9.5	2.5
15000	-15	70	523	21.6	31.6	10.1	2.7
16000	-17	70	491	23.5	35.1	10.7	2.8
17000	-19	70	459	25.6	38.9	11.3	3.0
18000	-21	70	426	27.9	43.0	11.9	3.1

Figure 5-2b Time, Fuel and Distance to Climb at 1134 kg (2500 lbs)

TIME, FUEL AND DISTANCE TO CLIMB AT 1111 kg (2450 lbs)

Conditions:

Takeoff weight 1111 kg (2450 lbs)

Climb speed $v_y = 70$ KIAS

Flaps Up

Full Power

Standard Temperature (ISA)

Notes:

1. Add 4 l (1.1 US gal) of fuel for engine start, taxi and takeoff allowance.
2. Increase time and distance by 10% for 10°C above standard temperature.
3. Distances shown are based on zero wind.
4. Time, distance and fuel required are only valid from the point where the airplane climbs at $v_y = 70$ KIAS.

Press. Alt. [ft]	OAT [°C]	Vy [KIAS]	ROC [FPM]	Time [MIN]	Distance [NM]	Fuel used	
						[l]	[US Gal]
0	15	70	823	0.0	0.0	0.0	0.0
1000	13	70	817	1.2	1.4	0.7	0.2
2000	11	70	811	2.4	2.9	1.4	0.4
3000	9	70	805	3.7	4.5	2.1	0.5
4000	7	70	798	4.9	6.1	2.8	0.7
5000	5	70	792	6.2	7.7	3.5	0.9
6000	3	70	785	7.5	9.5	4.2	1.1
7000	1	70	779	8.7	11.3	4.9	1.3
8000	-1	70	772	10.0	13.1	5.6	1.5
9000	-3	70	741	11.4	15.1	6.2	1.6
10000	-5	70	709	12.7	17.2	6.8	1.8
11000	-7	70	677	14.2	19.5	7.4	1.9
12000	-9	70	646	15.7	21.9	7.9	2.1
13000	-11	70	614	17.3	24.5	8.5	2.3
14000	-13	70	581	18.9	27.3	9.1	2.4
15000	-15	70	549	20.7	30.4	9.7	2.6
16000	-17	70	517	22.6	33.7	10.2	2.7
17000	-19	70	484	24.6	37.3	10.8	2.9
18000	-21	70	451	26.7	41.2	11.4	3.0

Figure 5-2c Time, Fuel and Distance to Climb at 1111 kg (2450 lbs)

MAXIMUM RATE-OF-CLIMB at 1157 kg (2550 lbs)

Conditions:

Take-off weight 1157 kg (2550 lbs)

Climb speed $v_y = 70$ KIAS

Flaps Up

Full Power

Notes:

1. For operation in air colder than this table provides, use coldest data shown.
2. For operation in air warmer than this table provides, use extreme caution.

PRESS ALT [FT]	Climb speed [KIAS]	Rate of Climb [ft/min]				
		Outside Air Temperature [°C]				
		-20°C	0°C	+20°C	+40°C	+50°C
0	70	792	777	763	658	533
1000	70	785	770	756	650	525
2000	70	778	763	748	643	517
3000	70	771	755	740	634	509
4000	70	763	748	732	626	501
5000	70	756	740	724	618	492
6000	70	748	731	716	609	483
7000	70	740	723	707	600	474
8000	70	731	714	698	591	465
9000	70	700	682	666	560	436
10000	70	667	650	633	528	407
11000	70	635	617	600	497	377
12000	70	602	584	566	465	348
13000	70	570	551	533	433	318
14000	70	537	517	499	401	288
15000	70	503	484	465	368	257
16000	70	469	450	430	335	226
17000	70	436	415	396	302	195
18000	70	401	381	361	268	164

Figure 5-3a Maximum Rate of Climb at take-off weight
 1157 kg (2550 lbs)

MAXIMUM RATE-OF-CLIMB at 1134 kg (2500 lbs)

Conditions:

Take-off weight 1134 kg (2500 lbs)

Climb speed $v_y = 70$ KIAS

Flaps Up

Full Power

Notes:

1. For operation in air colder than this table provides, use coldest data shown.
2. For operation in air warmer than this table provides, use extreme caution.

PRESS ALT [FT]	Climb speed [KIAS]	Rate of Climb [ft/min]				
		Outside Air Temperature [°C]				
		-20°C	0°C	+20°C	+40°C	+50°C
0	70	819	805	791	684	556
1000	70	812	798	783	676	549
2000	70	805	790	776	668	541
3000	70	798	783	768	660	533
4000	70	791	775	760	652	524
5000	70	783	767	752	644	516
6000	70	775	759	744	635	507
7000	70	767	751	735	626	498
8000	70	759	742	726	617	489
9000	70	727	710	693	586	460
10000	70	694	677	660	554	430
11000	70	662	644	627	522	401
12000	70	629	611	593	490	371
13000	70	595	577	559	458	341
14000	70	562	543	525	425	310
15000	70	528	509	490	392	279
16000	70	494	475	456	359	248
17000	70	460	440	420	325	217
18000	70	425	405	385	291	185

Figure 5-3b Maximum Rate of Climb at take-off weight
1134 kg (2500 lbs)

MAXIMUM RATE-OF-CLIMB at 1111 kg (2450 lbs)

Conditions:

Take-off weight 1111 kg (2450 lbs)

Climb speed $v_y = 70$ KIAS

Flaps Up

Full Power

Notes:

1. For operation in air colder than this table provides, use coldest data shown.
2. For operation in air warmer than this table provides, use extreme caution.

PRESS ALT [FT]	Climb speed [KIAS]	Rate of Climb [ft/min] Outside Air Temperature [°C]				
		-20°C	0°C	+20°C	+40°C	+50°C
0	70	847	833	819	710	581
1000	70	840	826	812	703	573
2000	70	834	819	804	695	565
3000	70	826	811	797	687	557
4000	70	819	804	789	679	549
5000	70	812	796	781	671	540
6000	70	804	788	772	662	532
7000	70	796	780	764	653	523
8000	70	788	771	755	644	514
9000	70	755	738	722	613	484
10000	70	722	705	688	581	455
11000	70	689	672	655	549	425
12000	70	656	638	621	516	394
13000	70	622	604	586	483	364
14000	70	588	570	552	450	333
15000	70	554	535	517	417	302
16000	70	520	500	482	383	271
17000	70	485	465	446	349	239
18000	70	450	430	410	315	207

Figure 5-3c Maximum Rate of Climb at take-off weight
 1111 kg (2450 lbs)

**CRUISE PERFORMANCE, RANGE AND ENDURANCE at
1157 kg (2550 lbs)****Conditions:**

Take-off weight 1157 kg (2550 lbs)
Flaps Up
Zero wind

Notes:

1. Endurance information are based on 168.8 l (44.6 US gal) usable fuel.
2. The table assumes 4 l (1.1 US gal) for startup and taxi; time, fuel and distance to climb and 45 min. reserve.
3. Increase true airspeed (KTAS) and maximum range (NM) by 1% per 10°C above ISA temperature.
4. Cruise Power above 75% not recommended. For economic cruise set load 70% or less.

Press. Alt.	Load	Speed		Fuel Flow		Distance	Endu- rance Time
		[ft]	[%]	[KTAS]	[mph]		
SL	100	125	143	33.6	8.9	517	4.2
SL	90	120	138	29.6	7.8	577	4.8
SL	80	115	132	25.8	6.8	646	5.6
SL	70	109	125	22.1	5.8	729	6.7
SL	60	102	117	18.6	4.9	825	8.1
SL	50	93	107	15.3	4.0	930	10.0
2000	100	127	146	33.6	8.9	524	4.0
2000	90	122	140	29.6	7.8	584	4.7
2000	80	117	134	25.8	6.8	653	5.5
2000	70	111	127	22.1	5.8	736	6.6
2000	60	103	119	18.6	4.9	832	8.0
2000	50	94	108	15.3	4.0	934	9.8
4000	100	129	149	33.6	8.9	531	3.9
4000	90	124	143	29.6	7.8	591	4.6
4000	80	119	137	25.8	6.8	661	5.4
4000	70	113	130	22.1	5.8	744	6.4
4000	60	105	121	18.6	4.9	839	7.8
4000	50	95	109	15.3	4.0	937	9.7
6000	100	132	152	33.6	8.9	538	3.8
6000	90	127	146	29.6	7.8	599	4.5
6000	80	121	139	25.8	6.8	668	5.3
6000	70	115	132	22.1	5.8	751	6.3
6000	60	107	123	18.6	4.9	845	7.6
6000	50	96	110	15.3	4.0	939	9.5
8000	100	134	155	33.6	8.9	545	3.7
8000	90	129	149	29.6	7.8	606	4.3
8000	80	123	142	25.8	6.8	675	5.1
8000	70	117	134	22.1	5.8	758	6.1
8000	60	108	125	18.6	4.9	850	7.5
8000	50	97	111	15.3	4.0	938	9.3
10000	90	132	151	29.6	7.8	613	4.2
10000	80	126	144	25.8	6.8	682	5.0

Press. Alt.	Load	Speed		Fuel Flow		Distance	Endurance Time
		[ft]	[%]	[KTAS]	[mph]		
10000	70	119	136	22.1	5.8	764	6.0
10000	60	110	126	18.6	4.9	855	7.3
10000	50	97	112	15.3	4.0	934	9.1
12000	90	134	154	29.6	7.8	620	4.0
12000	80	128	147	25.8	6.8	689	4.8
12000	70	121	139	22.1	5.8	771	5.8
12000	60	111	128	18.6	4.9	859	7.1
12000	50	97	112	15.3	4.0	926	8.9
14000	90	137	157	29.6	7.8	627	3.9
14000	80	130	150	25.8	6.8	696	4.6
14000	70	123	141	22.1	5.8	777	5.6
14000	60	113	130	18.6	4.9	862	6.9
14000	50	96	111	15.3	4.0	910	8.6
16000	80	133	153	25.8	6.8	703	4.4
16000	70	125	143	22.1	5.8	782	5.4
16000	60	114	132	18.6	4.9	864	6.6
16000	50	93	106	15.3	4.0	866	8.4
18000	80	135	156	25.8	6.8	709	4.2
18000	70	127	146	22.1	5.8	787	5.2
18000	60	115	133	18.6	4.9	864	6.4

Figure 5-4a Cruise Performance, Range and Endurance at 1157 kg (2550 lbs)

CRUISE PERFORMANCE, RANGE AND ENDURANCE at 1134 kg (2500 lbs)

Conditions:

Take-off weight 1134 kg (2500 lbs)
Flaps Up
Zero wind

Notes:

1. Endurance information are based on 168.8 l (44.6 US gal) usable fuel.
2. The table assumes 4 l (1.1 US gal) for startup and taxi; time, fuel and distance to climb and 45 min. reserve.
3. Increase true airspeed (KTAS) and maximum range (NM) by 1% per 10°C above ISA temperature.
4. Cruise Power above 75% not recommended. For economic cruise set load 70% or less.

Press. Alt.	Load	Speed		Fuel Flow		Distance	Endu- rance Time
		[ft]	[%]	[KTAS]	[mph]		
SL	100	125	143	33.6	8.9	518	4.2
SL	90	120	138	29.6	7.8	578	4.8
SL	80	115	132	25.8	6.8	647	5.6
SL	70	109	125	22.1	5.8	731	6.7
SL	60	102	117	18.6	4.9	828	8.1
SL	50	93	108	15.3	4.0	936	10.0
2000	100	127	146	33.6	8.9	525	4.0
2000	90	122	141	29.6	7.8	585	4.7
2000	80	117	134	25.8	6.8	655	5.5
2000	70	111	128	22.1	5.8	738	6.6
2000	60	104	119	18.6	4.9	835	8.0
2000	50	95	109	15.3	4.0	942	9.9
4000	100	129	149	33.6	8.9	532	3.9
4000	90	125	143	29.6	7.8	592	4.6
4000	80	119	137	25.8	6.8	662	5.4
4000	70	113	130	22.1	5.8	746	6.4
4000	60	105	121	18.6	4.9	843	7.8
4000	50	96	110	15.3	4.0	946	9.7
6000	100	132	152	33.6	8.9	539	3.8
6000	90	127	146	29.6	7.8	600	4.5
6000	80	121	140	25.8	6.8	670	5.3
6000	70	115	132	22.1	5.8	754	6.3
6000	60	107	123	18.6	4.9	850	7.7
6000	50	97	112	15.3	4.0	949	9.5
8000	100	135	155	33.6	8.9	546	3.7
8000	90	129	149	29.6	7.8	607	4.3
8000	80	124	142	25.8	6.8	677	5.1
8000	70	117	134	22.1	5.8	761	6.2
8000	60	109	125	18.6	4.9	856	7.5
8000	50	98	113	15.3	4.0	950	9.3
10000	90	132	152	29.6	7.8	614	4.2
10000	80	126	145	25.8	6.8	685	5.0

Press. Alt.	Load	Speed		Fuel Flow		Distance	Endu- rance Time
		[ft]	[%]	[KTAS]	[mph]		
10000	70	119	137	22.1	5.8	768	6.0
10000	60	111	127	18.6	4.9	862	7.3
10000	50	99	114	15.3	4.0	950	9.1
12000	90	134	155	29.6	7.8	622	4.1
12000	80	128	148	25.8	6.8	692	4.8
12000	70	121	139	22.1	5.8	775	5.8
12000	60	112	129	18,6	4.9	867	7.1
12000	50	99	114	15,3	4.0	946	8.9
14000	88	137	158	29,6	7.8	629	3.9
14000	80	131	150	25,8	6.8	699	4.7
14000	70	123	142	22,1	5.8	782	5.6
14000	60	114	131	18,6	4.9	871	6.9
14000	50	99	114	15,3	4.0	937	8.7
16000	80	133	153	25.8	6.8	707	4.5
16000	70	125	144	22.1	5.8	788	5.4
16000	60	115	133	18.6	4.9	874	6.7
16000	50	98	113	15.3	4.0	920	8.4
18000	80	136	156	25.8	6.8	705	4.2
18000	70	127	147	22.1	5.8	785	5.1
18000	60	117	134	18.6	4.9	866	6.3
18000	50	93	107	15.3	4.0	854	8.0

Figure 5-4b Cruise Performance, Range and Endurance at 1134 kg (2500 lbs)

**CRUISE PERFORMANCE, RANGE AND ENDURANCE at
1111 kg (2450 lbs)****Conditions:**

Take-off weight 1111kg (2450 lbs)
Flaps Up
Zero wind

Notes:

1. Endurance information are based on 168.8 l (44.6 US gal) usable fuel.
2. The table assumes 4 l (1.1 US gal) for startup and taxi; time, fuel and distance to climb and 45 min. reserve.
3. Increase true airspeed (KTAS) and maximum range (NM) by 1% per 10°C above ISA temperature.
4. Cruise Power above 75% not recommended. For economic cruise set load 70% or less.

Press. Alt.	Load	Speed		Fuel Flow		Distance	Endurance Time
		[ft]	[%]	[KTAS]	[mph]		
SL	100	125	144	33.6	8.9	518	4.2
SL	90	120	138	29.6	7.8	578	4.8
SL	80	115	132	25.8	6.8	648	5.6
SL	70	109	126	22.1	5.8	732	6.7
SL	60	102	118	18.6	4.9	831	8.1
SL	50	94	108	15.3	4.0	942	10.0
2000	100	127	146	33.6	8.9	525	4.1
2000	90	122	141	29.6	7.8	586	4.7
2000	80	117	135	25.8	6.8	656	5.5
2000	70	111	128	22.1	5.8	740	6.6
2000	60	104	120	18.6	4.9	839	8.0
2000	50	95	110	15.3	4.0	948	9.9
4000	100	130	149	33.6	8.9	532	4.0
4000	90	125	143	29.6	7.8	593	4.6
4000	80	119	137	25.8	6.8	664	5.4
4000	70	113	130	22.1	5.8	748	6.4
4000	60	106	122	18.6	4.9	846	7.8
4000	50	97	111	15.3	4.0	954	9.7
6000	100	132	152	33.6	8.9	540	3.8
6000	90	127	146	29.6	7.8	601	4.5
6000	80	121	140	25.8	6.8	671	5.3
6000	70	115	132	22.1	5.8	756	6.3
6000	60	108	124	18.6	4.9	854	7.7
6000	50	98	113	15.3	4.0	958	9.5
8000	100	135	155	33.6	8.9	547	3.7
8000	90	130	149	29.6	7.8	608	4.4
8000	80	124	142	25.8	6.8	679	5.2
8000	70	117	135	22.1	5.8	764	6.2
8000	60	109	126	18.6	4.9	861	7.5
8000	50	99	114	15.3	4.0	961	9.3
10000	90	132	152	29.6	7.8	616	4.2
10000	80	126	145	25.8	6.8	687	5.0

Press. Alt.	Load	Speed		Fuel Flow		Distance	Endurance Time
		[ft]	[%]	[KTAS]	[mph]		
10000	70	119	137	22.1	5.8	772	6.0
10000	60	111	128	18.6	4.9	867	7.4
10000	50	100	115	15.3	4.0	963	9.2
12000	90	135	155	29.6	7.8	624	4.1
12000	80	129	148	25.8	6.8	695	4.9
12000	70	121	140	22.1	5.8	779	5.9
12000	60	113	130	18.6	4.9	873	7.2
12000	50	101	116	15.3	4.0	962	9.0
14000	90	137	158	29.6	7.8	631	4.0
14000	80	131	151	25.8	6.8	702	4.7
14000	70	124	142	22.1	5.8	786	5.7
14000	60	115	132	18.6	4.9	879	7.0
14000	50	101	117	15.3	4.0	958	8.7
16000	80	133	154	25.8	6.8	710	4.5
16000	70	126	145	22.1	5.8	793	5.5
16000	60	116	134	18.6	4.9	883	6.8
16000	50	101	116	15.3	4.0	949	8.5
18000	80	136	157	25.8	6.8	720	4.4
18000	70	128	147	22.1	5.8	803	5.3
18000	60	118	136	18.6	4.9	890	6.6
18000	50	100	115	15.3	4.0	934	8.3

Figure 5-4c Cruise Performance, Range and Endurance at 1111 kg (2450 lbs)

SECTION 6 WEIGHT & BALANCE

Item	Weight x Arm = Moment		
	(kg)	(m)	(mkp)
Empty Weight			
plus Engine Oil (6 l to 0.9 kg/l)		-0.31	
plus Gearbox Oil (1 l to 0.9 kg/l)		-0.69	
plus unusable fuel (11.4 l to 0.84 kg/l)		1.17	
plus Coolant (4 l to 1.0 kg/l)		-0.26	
Changes in Equipment			
Basic Empty Weight			

Figure 6-1 Calculating the Basic Empty Weight

		Your aircraft	
		Mass kg	Moment mkp
Calculation of the loaded condition	1. Basic Empty Weight: Use the values for your airplane with the present equipment. Unusable fuel, engine oil, gearbox oil and coolant are included.		
	2. Usable Fuel (at 0.84 kg/l), max. 168.8l		
	3. Pilot and Front Passenger (Station 0.86 to 1.17 m)		
	4. Rear Passenger		
	5. *Baggage Area 1 or Passenger on the children's seat (Station 2.08 to 2.74; max.54kg)		
	6. *Baggage Area 2 (Station 2.74 to 3.61; max.23kg)		
	7. Ramp Weight and Moment		
	8. Fuel allowance for engine start, taxi and runup		
	9. Take-off Weight and Moment (Subtract Step 8 from Step 7)		
	10. Locate this point in the weight and balance envelope in the original POH. Check if its within the envelope. *Maximum allowable combined weight capacity for Baggage Areas 1 and 2 is 54 kg		

Figure 6-2 Calculating Weight and Moment

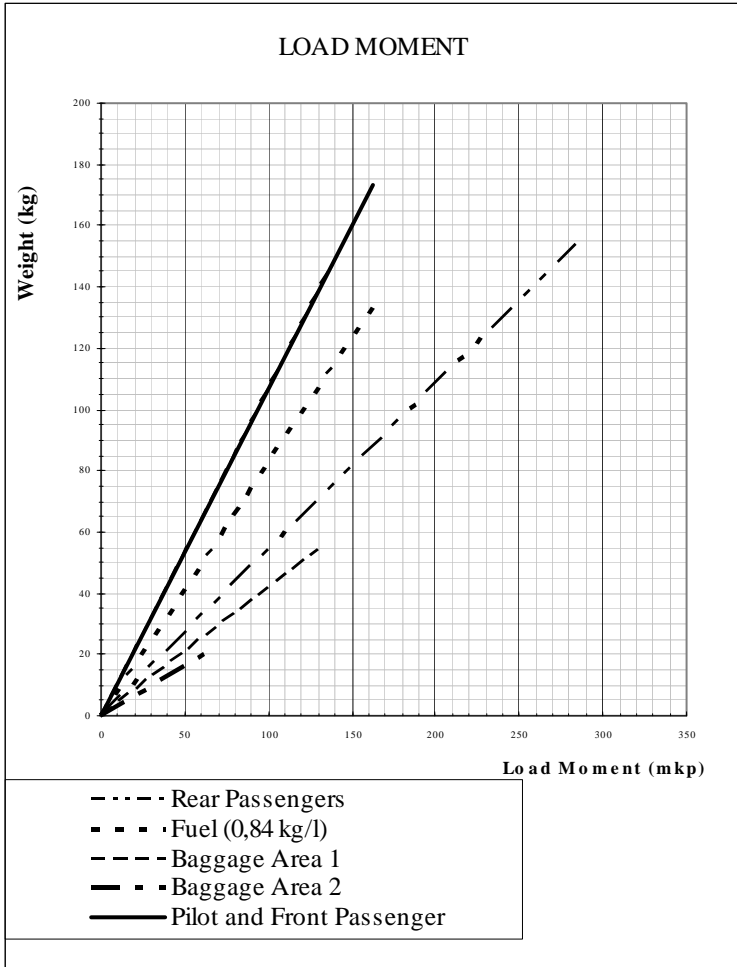

Figure 6-3 Load Moment

This page intentionally left blank

SECTION 7

AIRPLANE AND SYSTEMS DESCRIPTION

INSTRUMENT PANEL

Components of the new installation can be seen as example in the following figures.

1. CED/AED Engine Instruments

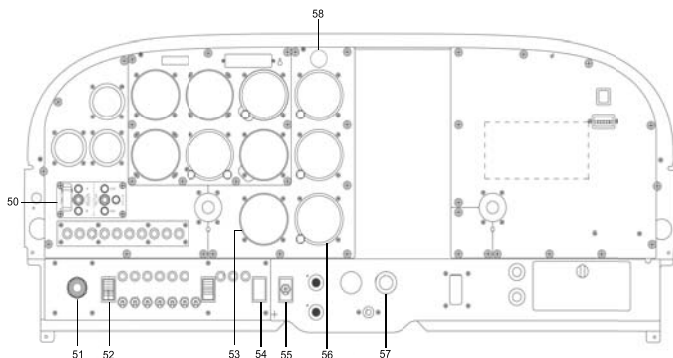

Figure 7-1 Example of Instrument panel
(CED/AED Engine Instruments)

50. Lightpanel with:

- Force B switch for manually switching the FADEC
- FADEC test knob
- FADEC A and B Warning Lights for FADEC A and B (red)
- AED Caution Lights (amber) for AED 125
- CED Caution Lights (amber) for CED 125
- CED/AED Test/Confirm knob for CED 125, AED 125 and Caution Lights (amber)
- Glow Control Light (amber)

51. Starter Push Button for Starter
52. BATT switch for Battery
53. CED 125 (Tachometer -N/A-)
The Compact Engine Display contains indication of Propeller Rotary Speed, Oil Pressure, Oil Temperature, Coolant Temperature, Gearbox Temperature and Load.
54. ALT switch for Alternator
55. Engine Master switch - electrical supply FADEC
56. AED 125 SR (Voltmeter) with indication of Fuel Temperature, Voltage and a Water Level caution light (amber) for low coolant level
57. Alt. Air Door - Alternate Air Door
58. AWL light - alternator warning light (red)

2. G1000 with Engine Indication System

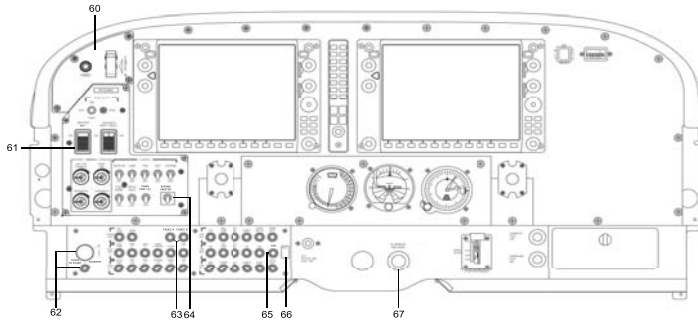

Figure 7-2 Example of Instrument Panel
(G1000 with Engine Indication System)

60. Switch Panel with:

- FADEC test knob
- Force B switch for manually switching the FADEC

61. MASTER BAT switch for Battery

62. Starter Push Button and Starter Circuit Breaker

63. Circuit Breakers FADEC A and FADEC B

64. Engine Master switch - electrical supply FADEC

65. Circuit Breaker AWL

66. ALT switch for Alternator

67. Alternate Air Door knob

FUEL SYSTEM

The fuel system of the TAE 125-02-114 installation includes the original tanks of the Cessna 172. Additional sensors for Fuel Temperature are installed.

The fuel flows out of the tanks to the Fuel Selector Valve with the positions LEFT, RIGHT and BOTH, through a reservoir tank to the fuel shut-off valve and then via the electrically driven Fuel Pump to the fuel filter.

The electrically driven Fuel Pump supports the fuel flow to the Filter Module if required. Then, the engine-driven feed pump and the high-pressure pump supply the rail, from where the fuel is injected into the cylinders depending upon the position of the thrust lever and regulation by the FADEC.

Surplus fuel flows to the fuel cooler and then through the Fuel Selector Valve back into the pre-selected tank, if BOTH is selected the fuel returns to both tanks. A temperature sensor in the Filter Module controls the heat exchange between the fuel feed and return. The fuel cooler reduces the fuel temperature in the return line.

The fuel cooler receives its cooling air through an inlet in the air duct to the heating radiator. This inlet is closed with a baffle, which must be removed at high outside air temperatures (OAT higher than 20 °C (68 °F), see also Section 4).

Since Diesel fuel tends to form paraffin at low temperatures, the information in Section 2 "Operating Limits" pertaining to fuel temperature must be monitored. The fuel return ensures a quicker warm up of the fuel in the tank in use.

If Diesel fuel is used, it shall meet DIN EN 590.

◆ Note: Approved fuels for use appear in Section 2.

C172 R&S normal category:

Total capacity:180.2 litres (47.6 US gallons)
Total capacity of usable fuel:168.8 litres (44.6 US gallons)
Total capacity of usable fuel
each tank:84.4 litres (22.3 US gallons)

C172 R&S utility category:

Total capacity:117.4 litres (31 US gallons)
Total capacity of usable fuel:106 litres (28 US gallons)
Total capacity of usable fuel
each tank:53 litres (14 US gallons)

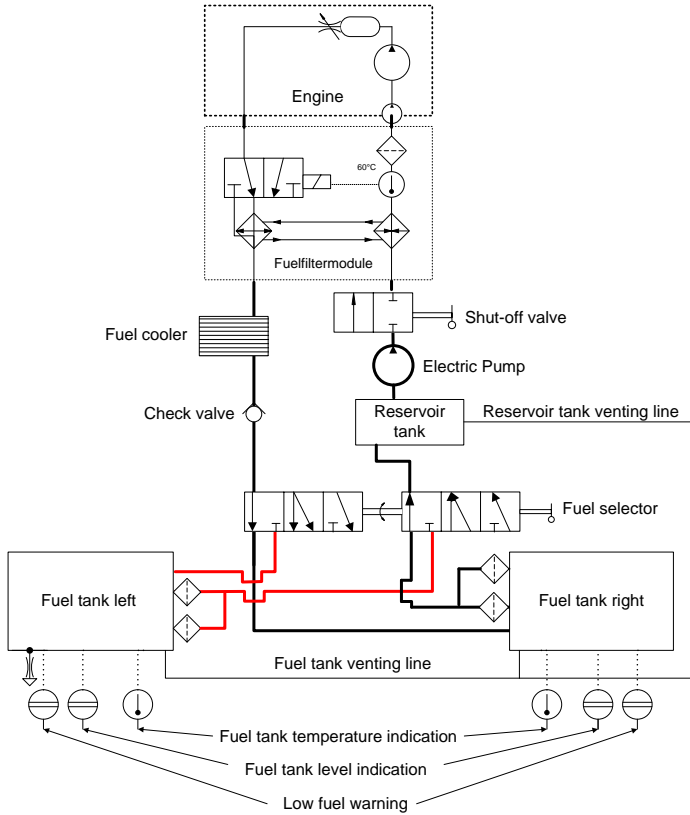

Figure 7-3 Scheme of the Fuel System

ELECTRICAL SYSTEM

The electrical system of the TAE 125-02-114 installations differs from the previous installation and is equipped with the following operating and display elements:

1. Alternator Switch
Controls the alternator; must be ON in normal operation
2. Battery Switch
Controls the Battery
3. Starter Push Button
Controls the magneto switch of the starter
4. Ammeter (AED/G1000 display)
The Ammeter shows the charging or discharging current to/from the battery.
5. Alternator Warning Light/Alternator Warning
Illuminates when the power output of the alternator is too low or the Circuit Breaker "Alternator" is switched off. Normally, this warning light always illuminates when the "Engine Master" is switched on without revolution and extinguishes immediately after starting the engine.
6. Fuel Pump Switch
This switch controls the electric fuel pump.
7. Engine Master Switch
Controls the two redundant FADEC components and the Alternator Excitation Battery with two independent contacts. The Alternator Excitation Battery is used to ensure that the Alternator continues to function properly even if the main battery fails.

▲ **WARNING:** If the Engine Master is switched off, the power supply to the FADEC is interrupted and the engine will shut down.

8. Force B Switch

If the FADEC does not automatically switch from A-FADEC to B-FADEC in case of an emergency despite of obvious necessity, this switch allows to switch to B-FADEC manually.

▲ **WARNING:** When operating on FADEC backup battery only, the Force B switch must not be activated. This will shut down the engine.

9. FADEC Backup Battery

The electrical system includes a FADEC backup battery to ensure power supply to A-FADEC in case that supply from both battery and alternator is interrupted. The engine can be operated for a maximum of 30 minutes when powered by the FADEC backup battery only. Only A-FADEC is connected to the backup battery

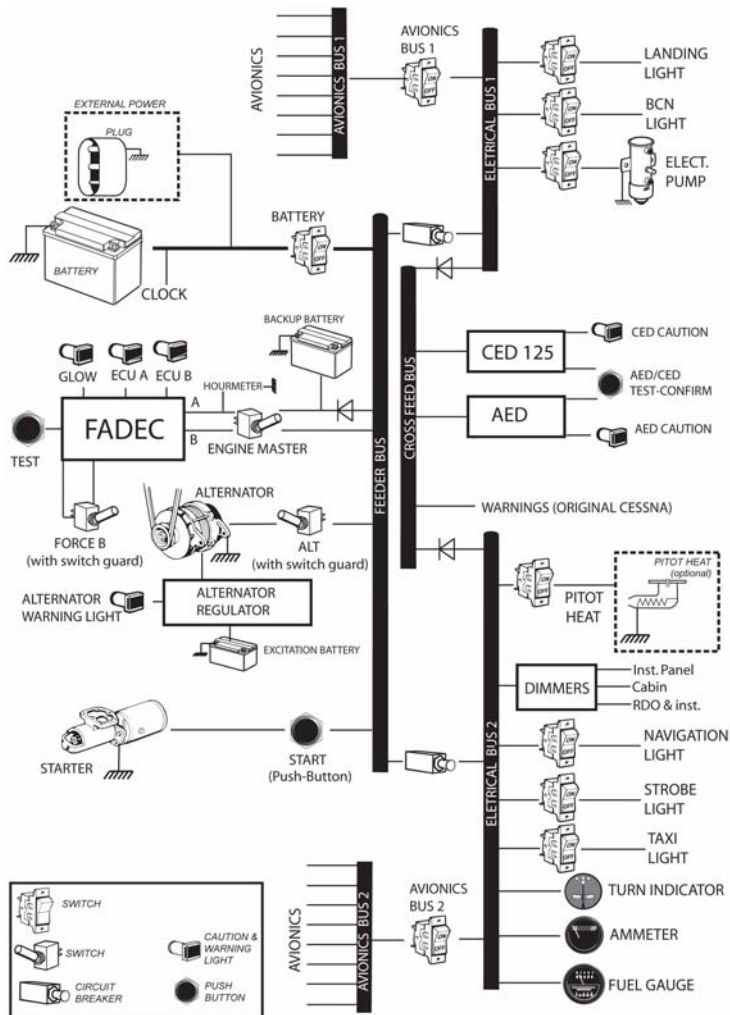

Figure 7-4 Basic Wiring of the Electrical System (CED/AED Engine Instruments)

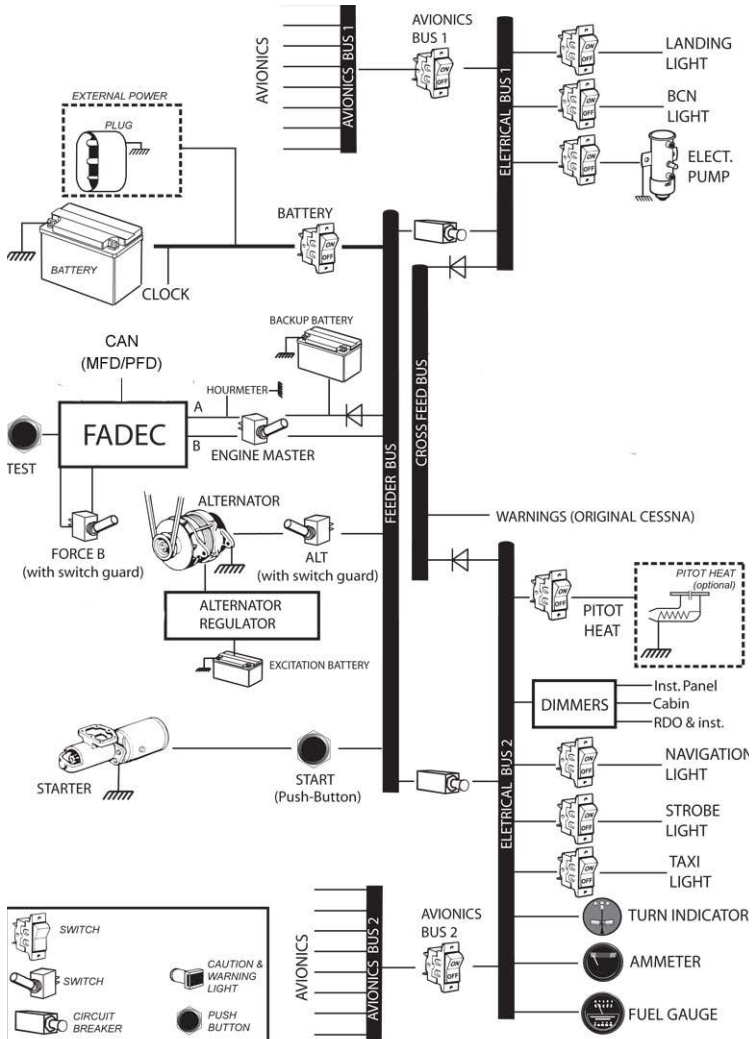

Figure 7-5 Basic Wiring of the Electrical System (G1000 with Engine Indication System)

FADEC RESET

In case of a FADEC warning, one or both FADEC warning lights are flashing (conventional avionics) or a warning is triggered (G1000 - ECU A FAIL or ECU B FAIL). If then the FADEC test knob/master warning switch is pressed for at least 2 seconds,

Conventional engine instruments (CED/AED):

- a) the active warning lights will extinguish if it was a LOW category warning.
- b) the active warning lights will be illuminated steady if it was a HIGH category warning.

G1000 with Engine Indication System:

- a) the message text will change to red text on black background.

■ **CAUTION:** If a FADEC warning occurred, contact your service center.

When a high category warning occurs the pilot should land as soon as possible, since the affected FADEC ECU has diagnosed a severe fault. A low category fault has no significant impact on engine operation.

Refer also to the engine OM-02-02 for additional information.

COOLING

The TAE 125-02-114 installation is fitted with a fluid-cooling system whose three-way thermostat regulates the flow of coolant between the large and small cooling circuit.

The coolant exclusively flows through the small circuit up to a cooling water temperature of 84°C and then between 84°C and 94°C both through the small and the large circuit.

If the cooling water temperature rises above 94°C, the complete volume of coolant flows through the large circuit and therefore through the radiator. This allows a maximum cooling water temperature of 105°C.

There is a sensor in the expansion reservoir which sends a signal to the warning light "Water level" on the instrument panel if the coolant level is low.

The cooling water temperature is measured in the housing of the thermostat and passed on to the FADEC and CED 125.

The connection to the heat exchanger for cabin heating is always open; the warm air supply is regulated by the pilot over the heating valve. See Figure 7-5.

The supply of warm air into the cabin is controlled through the cabin heat control knob. In normal operation, the cabin heat control knob must be in OPEN position.

In case of certain emergencies (refer to section 3), the control knob "Shut-off Cabin Heat" has to be closed according to the appropriate procedures.

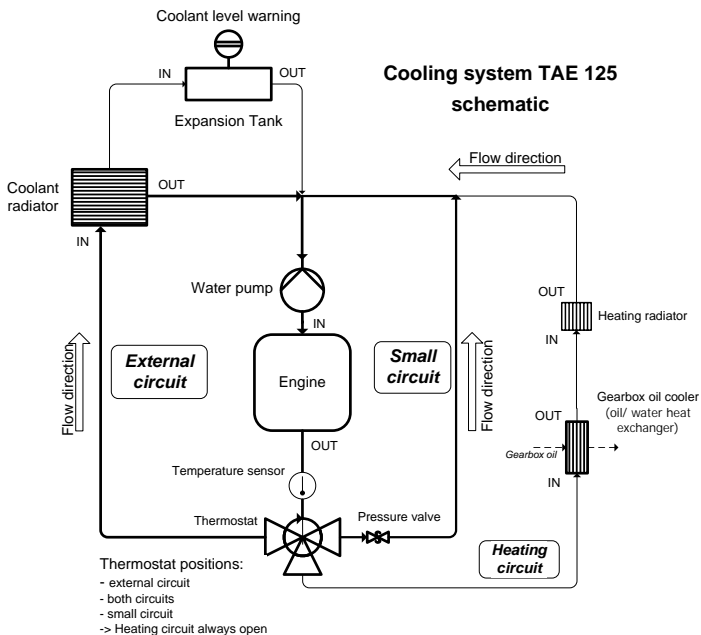

Figure 7-6 Cooling System

SECTION 8

AIRPLANE HANDLING, SERVICE AND MAINTENANCE

▲ **WARNING:** Do not start the engine in any case when filling levels are below the corresponding minimum marking.

■ **CAUTION:** Normally, a refill of coolant or gearbox oil between service intervals is not necessary. In case of low coolant or gearbox oil levels, inform the maintenance company immediately.

ENGINE OIL

The TAE 125-02-114 engine is filled with 4.5 - 6 l engine oil (refer to section 1 of this supplement for specification).

A dip stick is used to check the oil level. It is accessible by a flap on the upper right-hand side of the engine cowling.

Notice that on warm engines 5 minutes after engine shut-off there are 80% of the entire engine oil in the oil pan and therefore visible on the oil dipstick. On warm engines oil should be added if the oil dip stick shows oil levels below 50%. After 30 minutes the real oil level is visible on the dip stick.

The drain screw is located on the lower left-hand outside of the oil pan, the oil filter is on the upper left-hand side of the housing. The oil system has to be checked for sealing after the first 5 operating hours (visual inspection).

Checks and changes of oil and oil filter have to be performed regularly according to the Operation and Maintenance Manual, see OM-02-02. The Supplement of the Aircraft Maintenance Manual has to be considered as well, see AMM-20-02.

GEARBOX OIL

To ensure the necessary propeller speed, the engine is equipped with a reduction gearbox filled with gearbox oil. (refer to section 1 of this supplement for specification)

The level can be checked through a viewing glass on the lower leading edge of the gearbox. To do so, open the flap on the left front side of the engine cowling.

The drain screw is located at the lowest point of the gearbox. A filter is installed upstream of the pump, as well as microfilter in the Constant Speed Unit. Check the gearbox for sealing after the first 5 hours of operation (visual inspection). Regular checks as well as oil and filter changes have to be performed in accordance with the Operation and Maintenance Manual, see OM-02-02. The Supplement of the Aircraft Maintenance Manual has to be considered as well, see AMM-20-02.

▲ **WARNING:** It is not allowed to start the engine with low gearbox oil level.

■ **CAUTION:** Between scheduled maintenance topping-up gearbox oil should not be necessary. If low gearbox oil level is detected, inform your service center immediately.

FUEL

The engine can be operated with kerosene (JET A-1, Jet A, Fuel No.3, JP-8, TS-1) or Diesel fuel. Due to the higher specific density of turbine engine fuel or Diesel in comparison to aviation gasoline (AVGAS) the permissible capacity for standard tanks was reduced as mentioned in Section 1.

Appropriate placards are attached near the fuel filler connections. For temperature limitations refer to Section 2 "Limitations" and Section 4 "Normal Operation".

It is recommended to refuel before each flight and to enter the type of fuel into the log-book.

COOLANT

To cool the engine a liquid cooling system was installed with a water/approved radiator protection mixture at a ratio of 1:1. A heat exchanger for cabin heating is part of the cooling system. Check the cooling system for sealing after the first 5 hours of operation (visual inspection).

The coolant has to be changed in accordance with the Operations and Maintenance Manual, see OM-02-02. The Supplement of the Aircraft Maintenance Manual has to be considered as well, see AMM-20-02.

▲ **WARNING:** It is not allowed to start the engine with low level coolant.

■ **CAUTION:** Between scheduled maintenance topping-up coolant should not be necessary. If low coolant level is detected, inform your service centre immediately.

■ **CAUTION:** The water has to satisfy the following requirements:

- (1) Visual appearance: colorless, clear and no deposits allowed
- (2) pH-value: 6.5 to 8.5
- (3) maximum water hardness: 2.7 mmol/l
- (4) maximum hydrogen carbonate concentration: 100 mg/l
- (5) maximum chloride concentration: 100 mg/l
- (6) maximum sulfate concentration: 100 mg/l

◆ **Note:** The freezing point of the coolant is -36°C.

-
-
- ◆ Note: The waterworks also provide information. In general, tap water may be diluted with distilled water. Pure distilled water may not be used to mix with approved radiator protection.
-

SECTION 9 SUPPLEMENTS

TABLE OF CONTENTS

No supplements

This page intentionally left blank